

Canon

Canon

DIGITAL CAMERA



PowerShot SD20  
DIGITAL ELPH

DIGITAL  
IXUS i<sup>5</sup>

Camera User Guide

Canon



CDI-E154

ENGLISH



DiGiC



PictBridge



DIRECT PRINT



BUBBLE JET  
DIRECT

Exif Print



*PowerShot* SD20  
DIGITAL ELPH

DIGITAL  
IXUS i<sup>5</sup>

## Camera User Guide

Please read the *Read This First* section (p. 6).

Please also read the *Software Starter Guide* and the *Direct Print User Guide*.

## Flowchart and Reference Guides



**This Guide**

**Shooting with the Camera**



**Software Starter Guide**

**Installing the Software**



**This Guide**

**Connecting the Camera to a Computer**



**This Guide**



**Software Starter Guide**

**Downloading Images to a Computer**



**Direct Print User Guide**



**Printer User Guide**

**Using the Printer and Printing**

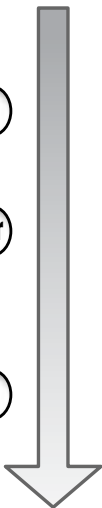

**Use of genuine Canon accessories is recommended.**

This product is designed to achieve excellent performance optimally when used with genuine Canon accessories. Canon shall not be liable for any damage to this product and/or accidents such as fire, etc., caused by the malfunction of non-genuine Canon accessories (e.g., a leakage and/or explosion of a battery pack). Please note that this warranty does not apply to repairs arising out of the malfunction of non-genuine Canon accessories, although you may request such repairs on a chargeable basis.

## **Camera Body Temperature**

If your camera is used for prolonged periods, the camera body may become warm. Please be aware of this and take care when operating the camera for an extended period.

## **About the LCD Monitor**

The LCD monitor is produced with extremely high-precision manufacturing techniques. More than 99.99% of the pixels operate to specification. Less than 0.01% of the pixels may occasionally misfire or appear as red or black dots. This has no effect on the recorded image and does not constitute a malfunction.

## **Video Format**

Please set the camera's video signal format to the one used in your region before using it with a TV monitor (p. 127).

## **Charging the Date/Time Battery**

- The camera has a built-in rechargeable lithium-ion battery that maintains the date, time and other camera settings. This battery recharges when the main battery pack is inserted into the camera. When you first purchase the camera, place a charged battery pack in it for at least 4 hours to charge the date/time battery. It will charge even when the camera power is turned off.
- If the Date/Time menu appears when the camera power is turned on, it means that the date/time battery charge is depleted. Recharge it as described above.

### Conventions Used in the Text

Icons appearing beside or below titles indicate the modes in which the procedure can be used. In the example below, the procedure can be used in the following mode.

When the mode switch is set to  (Shooting)







#### Postcard Date Imprint Mode



Shooting Mode



When the Shooting mode is set to the following modes

-  Manual
-  Macro
-  Portrait
-  Landscape
-  Night Snapshot
-  Indoor
-  Underwater

\* When a shooting mode icon is shown in gray, the procedure cannot be performed in that mode.

\* The  symbol indicates the Stitch Assist mode.



: This mark denotes issues that may affect the camera's operation.



: This mark denotes additional topics that complement the basic operating procedures.

### SET Button and FUNC. Button Descriptions

The “**SET/FUNC.** button” description refers to shooting instructions and the “**SET** button” description refers to all other instructions throughout this manual.

In this guide an SD memory card (Secure Digital, a copyright protection system) is referred to as an SD card.

## Table of Contents

Items marked with ☆ are lists or charts that summarize camera functions or procedures.

### Read This First

Please Read.....	6
Safety Precautions .....	7
Preventing Malfunctions .....	12

### Components Guide

Components Guide.....	13
-----------------------	----

### Preparing the Camera



Charging the Battery Pack.....	17
Installing the Battery Pack.....	20
Installing the SD Card .....	22
Formatting SD Cards.....	24
Setting the Date and Time .....	27
Setting the Language .....	30

### Basic Functions



Turning the Power On .....	32
Switching Between Shooting/Playback.....	34
Using the LCD Monitor.....	35
Information Displayed on the LCD Monitor .....	37
Using the Digital Zoom.....	42
Pressing the Shutter Button .....	43
☆ Selecting Menus and Settings .....	45
☆ Menu Settings and Factory Defaults.....	49
Resetting Settings to Their Default Values .....	54

### Shooting

Shooting in Auto Mode .....	55
Reviewing an Image Right after Shooting .....	56
Changing Resolution/Compression Settings .....	58
⚡ Using the Flash .....	60
Selecting a Shooting Mode .....	62
Auto .....	62
Manual .....	62

Macro .....	62
Portrait .....	62
Landscape .....	62
Night Snapshot.....	62
Indoor.....	62
Underwater.....	62
Shooting Close-Ups.....	64
Continuous Shooting .....	65
Postcard Date Imprint Mode.....	66
 Using the Self-timer .....	68
 Shooting a Movie.....	70
Shooting Panoramic Images (Stitch Assist) .....	72
Switching between Focusing Modes.....	75
Shooting Hard-to-Focus Subjects (Focus Lock) .....	76
Switching between Light Metering Modes.....	78
Adjusting the Exposure Compensation .....	79
Shooting in Long Shutter Mode.....	80
Adjusting the Tone (White Balance).....	82
Changing the Photo Effect .....	86
Adjusting the ISO Speed.....	87
Setting the Auto Rotate Function .....	88
Resetting the File Number .....	89

## Playback

Displaying Images Individually .....	91
  Magnifying Images.....	92
Viewing Images in Sets of Nine (Index Playback) .....	93
Viewing Movies .....	94
Editing Movies .....	96
Rotating Images in the Display .....	98
Attaching Sound Memos to Images.....	99
Auto Play .....	102
Protecting Images .....	103

## Erasing

 Erasing Single Images .....	104
Erasing All Images.....	105

## **Print Settings**

About Printing .....	106
Setting the DPOF Print Settings .....	108

## **Image Transmission Settings (DPOF Transfer Order)**

Selecting Images for Transferring .....	114
---	-----

## **Connecting the Camera to a Computer**

Connecting the Camera to a Computer .....	119
Computer System Requirements .....	119
Downloading Images by Direct Transfer .....	123
Connecting the Camera to the Computer to Download Images without Installing Software .....	125
Downloading Directly from an SD Card .....	125

## **Viewing Images on a TV set**

Viewing Images on a TV set .....	126
----------------------------------	-----

## **Customizing the Camera (My Camera Settings)**

Changing My Camera Settings .....	128
Registering My Camera Settings .....	130

## **List of Messages**

List of Messages .....	134
------------------------	-----

## **Troubleshooting**

Troubleshooting .....	136
-----------------------	-----

## **Appendix**

Camera Care and Maintenance .....	140
Specifications .....	141
Photo Tips and Information .....	148
☆ Functions Available in Each Shooting Mode .....	160

## Please Read

### Test Shots

Before you try to photograph important subjects, we highly recommend that you shoot several trial images to confirm that the camera is operating and being operated correctly.

Please note that Canon Inc., its subsidiaries and affiliates, and its distributors are not liable for any consequential damages arising from any malfunction of a camera or accessory, including SD memory cards, that results in the failure of an image to be recorded or to be recorded in a format that is machine readable.

### Warning Against Copyright Infringement

Please note that Canon digital cameras are intended for personal use and should never be used in a manner that infringes upon or contravenes international or domestic copyright laws and regulations. Please be advised that in certain cases the copying of images from performances, exhibitions, or commercial properties by means of a camera or other device may contravene copyright or other legal rights even if the image was shot for personal use.

### Warranty Limitations

This camera's warranty is only effective in the country of sale. If a problem arises while the camera is in use abroad, please convey it back to the country of sale before proceeding with a warranty claim to a Canon Customer Support Help Desk.

**For Canon Customer Support contacts, please see the Canon Limited Warranty supplied with your camera.**



## Safety Precautions

- Before using the camera, please ensure that you read and understand the safety precautions described below. Always ensure that the camera is operated correctly.
- The safety precautions noted on the following pages are intended to instruct you in the safe and correct operation of the camera and its accessories to prevent injuries or damage to yourself, other persons and equipment.
- In the next few pages, the term equipment refers primarily to the camera and its power supply accessories and its power supply accessories (see the *System Map* for power supply accessory details).

### **Storing SD cards**

**Store the SD memory card out of the reach of children and infants.**

It may be swallowed accidentally. If this occurs, consult a doctor immediately.

### **Warnings**

- 
- **Do not aim the camera directly into the sun or at other intense light sources that could damage your eyesight.**
- 
- **Do not trigger the flash in close proximity to human or animal eyes.** Exposure to the intense light produced by the flash may damage eyesight. In particular, remain at least one meter (39 inches) away from infants when using the flash.
- 
- **Store this equipment out of the reach of children and infants.** Accidental damage to the camera or battery pack by a child could result in serious injury. In addition, placement of the strap around the child's neck could result in asphyxiation.
- 
- **Do not attempt to disassemble or alter any part of the equipment that is not expressly described in this guide.** Disassembly or alteration may result in high-voltage electrical shock. Internal inspections, alterations and repairs should be conducted by qualified service personnel authorized by your camera distributor or a Canon Customer Support Help Desk.
-

- 
- **To avoid the risk of high-voltage electrical shock, do not touch the flash portion of the camera if it has been damaged.** Similarly, never touch internal portions of the equipment that become exposed as a result of damage. There is a risk of high-voltage electrical shock. Please take the first opportunity to consult your camera distributor or the closest Canon Customer Support Help Desk.
- 
- **Stop operating the equipment immediately if it emits smoke or noxious fumes.** Failure to do so may result in fire or electrical shock. Immediately turn the camera power off, remove the camera battery or unplug the battery charger from the power outlet. Confirm that smoke or fume emissions have ceased. Please consult your camera distributor or the closest Canon Customer Support Help Desk.
- 
- **Stop operating the equipment if it is dropped or the casing is damaged.** Failure to do so may result in fire or electrical shock. Immediately turn the camera power off, remove the camera battery pack or unplug the battery charger from the power outlet. Please consult your camera distributor or the closest Canon Customer Support Help Desk.
- 
- **Do not allow the equipment to come into contact with, or become immersed in, water or other liquids.** Do not allow liquids to enter the interior. The camera has not been waterproofed. If the exterior comes into contact with liquids or salt air, wipe it dry with a soft, absorbent cloth. If water or other foreign substances enter the interior, immediately turn the camera power off and remove the camera battery pack or unplug the battery charger from the power outlet. Continued use of the equipment may result in fire or electrical shock. Please consult your camera distributor or the closest Canon Customer Support Help Desk.
- 
- **Do not use substances containing alcohol, benzene, thinners or other flammable substances to clean or maintain the equipment.** The use of these substances may lead to fire.
- 
- **Remove the power cord on a regular periodic basis and wipe away the dust and dirt that collects on the plug, the exterior of the power outlet and the surrounding area.** In dusty, humid or greasy environments, the dust that collects around the plug over long periods of time may become saturated with humidity and short-circuit, leading to fire.
-

- 
- **Do not cut, damage, alter or place heavy items on the power cord.** Any of these actions may cause an electrical short circuit, which may lead to fire or electrical shock.
- 
- **Do not handle the power cord if your hands are wet.** Handling it with wet hands may lead to electrical shock. When unplugging the cable, ensure that you hold the solid portion of the plug. Pulling on the flexible portion of the cable may damage or exposure the wire and insulation, creating the potential for fires or electrical shocks.
- 
- **Use only recommended power accessories.** Use of power sources not expressly recommended for this equipment may lead to overheating, distortion of the equipment, fire, electrical shock or other hazards.
- 
- **Do not place the battery pack near a heat source or expose it to direct flame or heat.** Neither should you immerse it in water. Such exposure may damage the battery pack and lead to the leakage of corrosive liquids, fire, electrical shock, explosion or serious injury.
- 
- **Do not attempt to disassemble, alter or apply heat to the battery pack.** There is serious risk of injury due to an explosion. Immediately flush with water any area of the body - including the eyes and mouth, or clothing - that comes into contact with the inner contents of a battery. If the eyes or mouth contact these substances, immediately flush with water and seek medical assistance.
- 
- **Avoid dropping or subjecting the battery pack to severe impacts that could damage the casings.** It could lead to leakage and injury.
- 
- **Do not short-circuit the battery terminals with metallic objects, such as key holders.** It could lead to overheating, burns and other injuries. Use the supplied terminal cover to transport or store the battery pack.
- 
- **Before you discard a battery, cover the terminals with tape or other insulators to prevent direct contact with other objects.** Contact with the metallic components of other materials in waste containers may lead to fire or explosions. Discard the battery pack in specialized waste facilities if available in your area.
- 
- **Use only recommended battery pack and accessories.** Use of battery pack not expressly recommended for this equipment may cause explosions or leaks, resulting in fire, injury and damage to the surroundings.
-

- 
- **Use the specified battery charger to charge Battery Pack NB-3L.** Use of other chargers may lead to overheating, distortion of the equipment, fire or electrical shock.
  - **Disconnect the battery charger from the power outlet after recharging and when it is not in use to avoid fire and other hazards.** Continuous use over a long period may cause a unit to overheat and distort, resulting in fire.
  - **The camera terminal of the battery charger is designed for exclusive use with your camera.** Do not use it with other products or batteries. There is a risk of fire and other hazards.
- 

### **Caution about magnetic fields**

Keep objects that are sensitive to magnetic fields (such as credit cards) away from the speaker of the camera (p. 13). Such items may lose data or stop working.

## **Cautions**

---

- **Avoid using, placing or storing the equipment in places subject to strong sunlight or high temperatures, such as the dashboard or trunk (boot) of a car.** Exposure to intense sunlight and heat may cause the batteries to leak, overheat or explode, resulting in fire, burns or other injuries. High temperatures may also cause deformation of the casing. Ensure that there is good ventilation when using the battery charger to charge the battery pack.

---

  - **Do not store the equipment in humid or dusty areas.** Storage in such areas could lead to fire, electrical shock or other damage.

---

  - **Be careful not to bang the camera or subject it to strong impacts or shocks that could lead to injury or damage the equipment when wearing or holding it by the strap.**

---

  - **Be careful not to touch the interior of the battery compartment.** This could lead to injuries or damage the camera.

---

  - **Be careful not to cover the flash with your fingers or clothing when shooting.** The flash may be damaged and emit smoke or noise. In addition, do not touch the surface of the flash after taking several pictures in rapid succession. Either action could result in burns.

---

  - **Do not operate the flash with dirt, dust or other items stuck to its lens.** The resulting heat build-up could damage the flash.

---

  - **Ensure that the battery charger is plugged into a power outlet of the specified rating, not over the specified rating.** The plug of the battery charger varies according to region.

---

  - **Do not use the battery charger if the plug is not fully inserted into the power outlet.**

---

  - **Do not allow metal objects (such as pins or keys) or dirt to contact the charger terminals or plug.**

---

  - **If your camera is used for prolonged periods, the camera body may become warm.** Please take care when operating the camera for extended periods as your hands may experience a burning sensation.
-

## Preventing Malfunctions

### **Avoid Strong Magnetic Fields**

Never place the camera in close proximity to electric motors or other equipment generating strong electromagnetic fields. Exposure to strong magnetic fields may cause malfunctions or corrupt image data.

### **Avoid Condensation Related Problems**

Moving the equipment rapidly between hot and cold temperatures may cause condensation (water droplets) to form on its external and internal surfaces. You can avoid this by placing the equipment in an airtight, resealable plastic bag and letting it adjust to temperature changes slowly before removing it from the bag.

### **If Condensation Forms Inside the Camera**

Stop using the camera immediately if you detect condensation. Continued use may damage the equipment. Remove the SD card and battery pack from the camera and wait until the moisture evaporates completely before resuming use.

### **Extended Storage**

When not using the camera for extended periods of time, remove the battery pack from the camera or battery charger and store the equipment in a safe place. Storing the camera for extended periods with a battery pack installed will run down the battery pack. However the date, time and other camera settings may reset to default settings if the battery pack has been removed for more than three weeks.

Front View

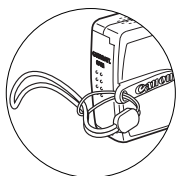
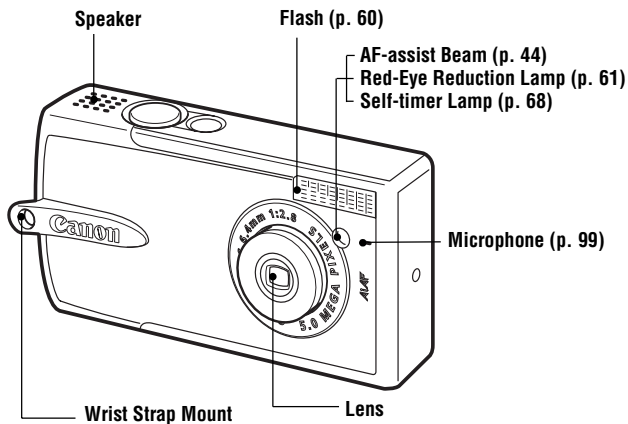

Attaching the Wrist Strap\*

\* When carrying the camera by the strap, be careful not to swing the camera or catch it on other items.

## Back View

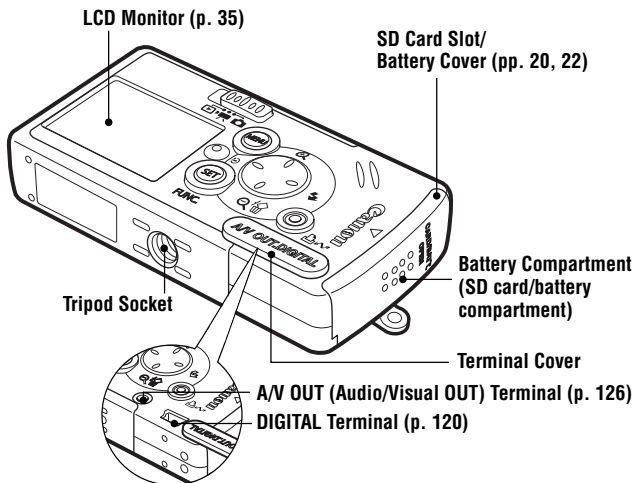

The following cables are used to connect the camera to a computer or printer.

### Computer (p. 118)

Interface Cable IFC-400PCU (supplied with the camera)

### Direct Print Compatible Printers (Sold Separately)

- Compact Photo Printer (SELPHY CP series)/Card Photo Printer  
Interface Cable IFC-400PCU (supplied with the camera) or the Direct Interface Cable DIF-100 (supplied with the printer).
- Bubble Jet Printers (PIXMA series/SELPHY DS series).
  - *Canon Direct Print* Compatible Printers:  
Please refer to your Bubble Jet printer user guide.
  - *PictBridge* Compliant Printers:  
Interface Cable IFC-400PCU (supplied with the camera)
- *PictBridge* Compliant Non-Canon Printers  
Interface Cable IFC-400PCU (supplied with the camera)

Please refer to the **System Map** or the **Direct Print User Guide** supplied with the camera for direct print compatible printer information.



# Operation Panel

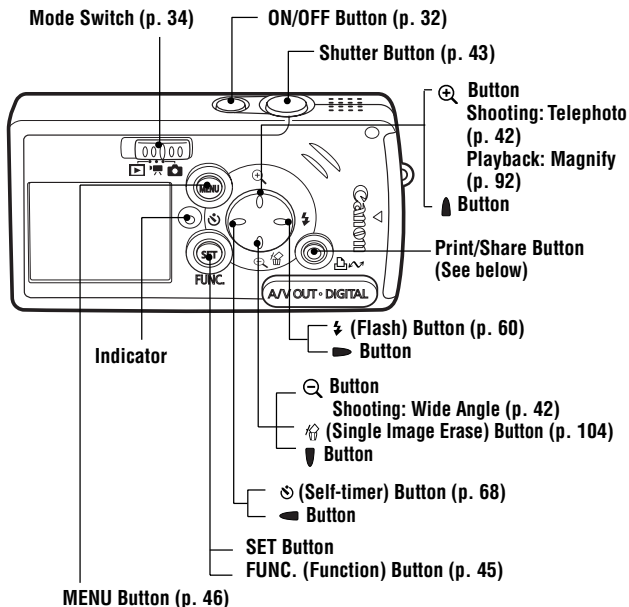

The following operations are accessible through one easy press of the

 (Print/Share) button.

- Printing: See the *Direct Print User Guide* (supplied with the camera)
- Downloading images (Windows only): See p.118 of this guide and the *Software Starter Guide* (supplied with the camera)

The indicator blinks or lights during a printer or computer connection.

Blue: Ready to print/Ready to transfer images

Blinking blue: Printing/Transferring

## Indicator

The indicator lights or blinks when the **ON/OFF** button or shutter button is pressed.

**Green:** Ready to shoot/LCD monitor Off/Computer connection

**Blinking Green:** Starting-up/Recording to SD card/Reading SD card/  
Erasing from SD card/Transmitting data (during a computer connection)

**Orange:** Ready to shoot (flash on)

**Blinking Orange:** Ready to shoot (camera shake warning)

\* If the subject is difficult to focus on, a single beep will sound. Although you can still press the shutter button when the indicator blinks orange, you are recommended to use the focus lock (p. 76).

## Holding the Camera

Images become blurred if the camera moves when the shutter button is pressed. Hold the camera as shown below to avoid camera movement when shooting.

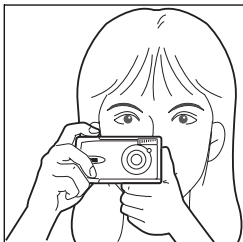

Hold the camera firmly with both hands and let your elbows rest at your sides. Place your finger on the shutter button as you hold the camera.

- Make sure that your hair or fingers do not obstruct the lens, flash, self-timer lamp, microphone or speaker.
- Fix the camera onto a tripod when shooting infinity shots or in dark places.

## Charging the Battery Pack

Use the following procedures to charge the battery pack the first time you use the camera or when the “Change the battery pack” message displays.

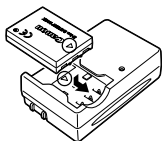

### 1 Insert the battery pack into the battery charger.

Align the battery pack according to the arrows on the battery and the charger. Insert the battery securely.



Charge Indicator

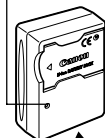

### 2 Battery charger model names and types vary by region.

(For CB-2LU)

**Plug the battery charger into a power outlet.**

(For CB-2LUE)

**Attach the power cord to the battery charger and plug it into a power outlet.**

- The charge indicator will light red while the battery pack is charging. It will change to green when the charge is complete.
- After charging, immediately unplug the battery charger and remove the battery pack.



---

To protect the battery pack and prolong its life, do not charge it for longer than 24 hours continuously.

---



- Since this is a lithium ion battery pack, you need not completely discharge it before recharging. It can be recharged at any point. However, since the maximum number of charge cycles is approximately 300 times (battery life, based on Canon's testing standards), you are recommended to charge the battery pack after having discharged it completely to prolong battery life.
- It takes approximately 95 minutes to fully charge the battery pack from a fully discharged state (based on Canon's testing standards). Charging it within a temperature range of 5° to 40 °C (41° to 104 °F) is recommended.
- Charge times may vary according to the ambient temperature and the battery pack's charge state.
- You may hear a noise during charging. This is not a malfunction.
- See *Battery Performance* (p. 144).

## Battery Pack Handling Precautions

- Keep the battery pack terminals ( $\oplus$   $\ominus$ ) clean at all times. Dirty terminals may cause poor contact between the battery pack and camera. Polish the terminals with a tissue or a dry cloth before charging or using the battery pack.
- Do not rapidly overturn or wave the battery charger around when it contains the battery pack. The battery pack could fly out.
- At low temperatures, battery pack performance may be reduced and the low battery icon may appear earlier than usual. Under these conditions, resuscitate the battery pack by warming it in a pocket immediately before use. However, ensure that there are no metallic items in the pocket that could cause a short circuit, such as a key holder, etc.
- Do not place anything, such as tablecloths, carpets, bedding or cushions, on top of the battery charger while it is charging. Heat will build up and could result in a fire.
- Do not charge batteries other than Battery Pack NB-3L in this charger.
- The battery pack continues to discharge a minimal portion of its power while installed in the camera, even with the power off, or in the charger. This will shorten battery life.
- Do not allow any metal objects such as key rings to touch the  $\oplus$  and  $\ominus$  terminals (Fig. A), as this can damage the battery pack. To carry the battery pack or store it during periods of disuse, always replace the terminal cover (Fig. B).
- Even charged battery packs continue to discharge naturally. You are advised to charge the battery on the day of use, or one day before, to ensure a full charge.
- Since storing a fully charged battery pack for long periods of time (about one year) may shorten its life cycle or affect its performance, you are recommended to use it in the camera until it is completely discharged and to store it in a cool place at room temperature (0 °C to 30 °C). If you do not use the battery pack for long periods of time, charge it fully and discharge it fully in the camera about once a year before returning it to storage.
- If the performance of the battery pack diminishes substantially even when it is fully charged, its life has been exceeded and it should be replaced.

Fig. A



Fig. B



## Installing the Battery Pack

Install Battery Pack NB-3L (supplied).



Please charge the battery pack (p. 17) before you use it for the first time.

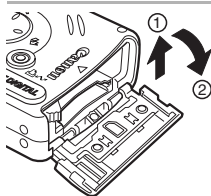

**1** Slide the SD card slot/battery cover in the direction of the arrows.

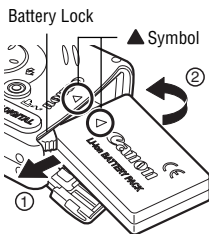

**2** Press the battery lock while inserting the battery pack all the way in until the lock clicks.

Align the ▲ symbols on the battery pack and camera back and insert it correctly.

- To remove the battery pack, pull the battery pack out while pressing the battery lock in the direction of ①.

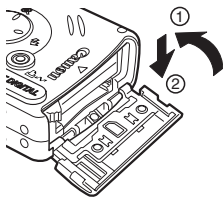

**3** Slide the SD card slot/battery cover closed.



- Please watch the loading slot area carefully as you insert and remove the battery pack.
- Do not turn off the power or open the SD card slot/battery cover while the indicator blinks green. The camera is writing, reading, erasing or transmitting an image to or from the SD card.
- Remove the battery pack when the camera is not in use. Please note, however, that the date, time and other camera settings may reset to the default settings if the battery pack has been removed for more than three weeks.

## Battery Pack Charge

The following icons and messages will display when the battery pack charge is low.

	<p>Battery pack charge is low. Recharge it as soon as possible before it is required for an extended period.</p> <p>When the LCD monitor is off, this icon will display when you press any button other than the <b>ON/OFF</b> button or  button.</p>
<p><b>Change the battery pack</b></p>	<p>Battery charge is insufficient to operate the camera. Replace the battery pack immediately.</p>



See *Battery Performance* (p. 144).

## Installing the SD Card

### Write Protect Tab

The SD card has a write protect tab. Sliding the tab downward prevents recording of data and protects existing data (e.g. images). When recording to, erasing from or formatting the SD card, slide the tab upward.

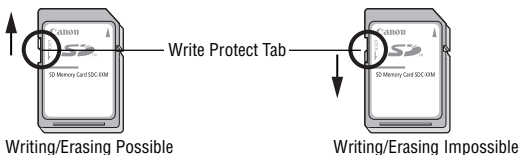

Turn the camera power off and insert the SD card with the following procedures.

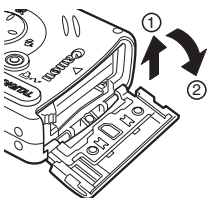

**1** Slide the SD card slot/battery cover in the direction of the arrows.

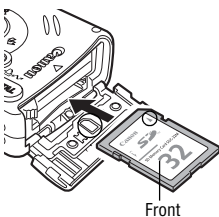

**2** Insert the SD card.

- Insert the SD card as shown on the inside of the battery cover until you hear it click into place.
- Do not touch or allow metal objects to contact the terminals on the back of the SD card.



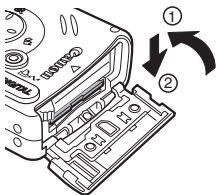

**3** Slide the SD card slot/battery cover closed.

### To remove the SD card

Push in the SD card until you hear it click, then release it.

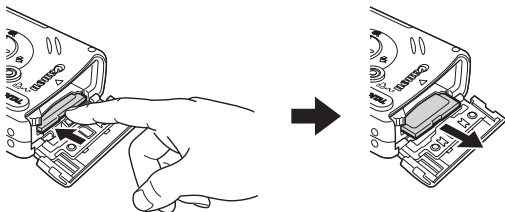

- Please watch the loading slot area carefully as you insert and remove the SD card.
- Since the camera is writing, reading, erasing or transmitting data to or from the SD card when the indicator blinks green, never perform the following actions during this time. It could corrupt the image data.
  - Subject the camera body to vibration or shocks.
  - Turn the camera's power off, or open the SD card slot/battery cover.
- Please note that SD cards formatted with other manufacturers' cameras or a computer, or formatted or edited with application programs, may slow down writing to the SD card or may not operate correctly in the camera.
- You are recommended to use SD cards that have been formatted in your camera (p. 24). The card supplied with the camera may be used without further formatting.



See *SD Cards and Estimated Capacities* (p. 145).

## Formatting SD Cards

You should always format a new SD card or one from which you wish to erase all images and other data.



Please note that formatting (initializing) an SD card erases all data, including protected images and other file types.

ON/OFF



**1** Press the ON/OFF button until the indicator blinks green.



**2** Press the MENU button.

The  (Rec.) or  (Play) menu is displayed.



**3** Use the  button to select the  (Set up) menu.



**4** Use the  or  button to select and press the SET button. 

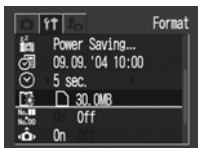



## 5 Use the **▶** button to select [OK] and press the SET button.

- To exit instead of formatting, select [Cancel].
- The capacity of the SD card displayed after formatting will be less than the rated capacity of the SD card. This is not a malfunction of the SD card or camera.



- When the camera is malfunctioning, a corrupted SD card might be the cause. Reformatting the SD card may solve the problem.
- When a non-Canon brand SD card is malfunctioning, reformatting it may solve the problem.
- SD cards formatted in other cameras, computers, or peripheral devices may not operate correctly in this camera. When that happens, reformat the SD card with this camera. If formatting in the camera does not work properly, turn the camera off and re-insert the SD card. Then turn the camera back on and format again.

### **SD Card Handling Precautions**











- SD cards are high-precision electronic devices. Do not bend them, apply force to them, or subject them to shocks or vibration.
- Do not attempt to disassemble or alter the SD card.
- Do not allow dirt, water or foreign objects to contact the terminals on the back of the card. Do not touch the terminals with your hands or metal objects.
- Do not peel away the original label on the SD card or cover it with another label or sticker.
- When writing on the SD card, use a soft point pen (e.g. felt-tip pen). Using a sharp point pen (e.g. ball-point pen) or pencil may damage the SD card or corrupt the recorded data.
- Since some or all of the data recorded on the SD card may be corrupted or erased by electrical noise, static electricity or card malfunction, making a backup copy of important data is recommended.
- Moving an SD card rapidly between temperature extremes will cause condensation to form in the card and lead to a malfunction. To avoid condensation, place the SD card in a sealed plastic bag before moving it into a different temperature zone and allow it to adjust slowly to the new temperature.
- If condensation forms on the SD card, store it at room temperature until the water droplets have evaporated naturally.
- Do not use or store SD cards in the following locations.
  - Locations subject to dust or sand
  - Locations subject to high humidity and high temperatures

### **Precaution for Multi Media Cards**

This camera is designed to perform optimally when used with genuine Canon-brand SD cards. You may use multi media cards (MMC) with this camera. However, Canon makes no warranties concerning the use of multi media cards (MMC).

## Setting the Date and Time

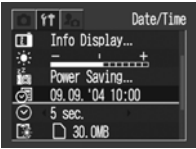
The Date/Time menu will appear the first time the camera power is turned on or whenever the built-in rechargeable lithium date/time battery charge is low. Start from Step 5 to set the date and time.

	<p><b>1</b> Press the <b>ON/OFF</b> button until the indicator blinks green.</p>
	<p><b>2</b> Press the <b>MENU</b> button. The  (Rec.) or  (Play) menu is displayed.</p>
 	<p><b>3</b> Use the <b>▶</b> button to select the  (Set up) menu.</p>
  	<p><b>4</b> Use the <b>▲</b> or <b>▼</b> button to select  and press the <b>SET</b> button.</p>

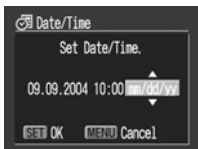

## 5 Set the date and time.

- Use the ◀ or ▶ button to select a field (year, month, day, hour, minute and date format).
- Use the ▲ or ▼ button to change its value.



## 6 Press the SET button.

The setting is complete.



## 7 Press the MENU button.

The display will return to the shooting or playback screen.



- Please note that the date and time settings may reset to the default settings if the camera battery has been removed for more than three weeks. Reset them when this occurs.
- For embedding the date on the image data, refer to page 67.
- To set the camera so that the date and time will not appear on the image when it is being shot but only when it is printed, see *Setting the Print Style* (p. 112), the *Direct Print User Guide* or the *Software Starter Guide* supplied with the camera.



### Charging the Date/Time Battery

- The camera has a built-in rechargeable lithium-ion battery for saving settings such as the date and time. This battery is recharged by the battery pack while it is in the camera. Right after purchasing the camera, leave a charged battery pack in the camera for about 4 hours to charge the date/time battery. It will charge even when the camera power is turned off.
- If the Date/Time menu appears when the camera power is turned on, the date/time battery charge is low. Use the above method to recharge it.

## Using the Clock

You can display the current date and time for a 5-second\* interval using the following methods. This is convenient for confirming the shooting date and time.

\* Default setting



- **Holding the SET Button While Pressing the ON/OFF Button**
  - The start-up image will not display at startup, also the start-up sound will not play.
  - The Date/Time menu will display if the time has not been set.
  - The Display Off function will not work while the clock display is on.
- **Pressing and Holding the SET/FUNC. Button in Shooting Mode**

The clock display will differ according to the camera orientation.

- Camera held horizontally: only the time displays
- Camera held vertically: both the time and date display

While the clock display is on, you can change the display color by pressing the ◀ or ▶ button or by gently shaking the camera as shown in the illustration. Feel free to change to your preferred color.

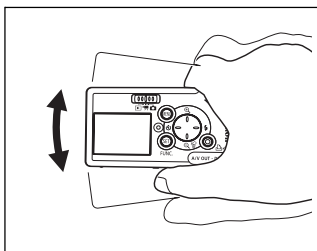

The clock display will cease when the display interval is over or when you operate any one of the **SET/FUNC.**, **MENU** or Shutter buttons or the mode switch.

- The clock cannot be displayed when menus are displayed with the **MENU** button.
- The clock's display time can be changed in the **f1** (Set up) menu (p. 52).



## Setting the Language

Use this feature to select the language for the LCD monitor display.



**1** Press the ON/OFF button until the indicator blinks green.



**2** Press the MENU button.  
The  (Rec.) or  (Play) menu is displayed.



**3** Use the  button to select the  (Set up) menu.



**4** Use the  or  button to select  and press the SET button.

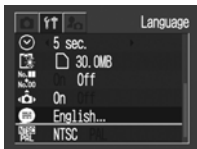





English	Norsk	Polski
Deutsch	Svenska	Čeština
Français	Español	Magyar
Nederlands	简体中文	Türkçe
Dansk	Русский	繁體中文
Suomi	Português	한국어
Italiano	Ελληνικά	日本語



**5** Use the ▲, ▼, ◀ or ▶ button to select a language and press the SET button.



**6** Press the MENU button.

The display will return to the shooting or playback screen.





The Language menu can also be displayed in playback mode by holding down the **SET** button and pressing the **MENU** button. This function cannot be used while a movie clip is played back, or a separately sold printer is connected to the camera.

### Turning the Power On

ON/OFF



**Press the ON/OFF button until the indicator blinks green.**

- The lens extends when the mode switch is set to  or .

#### To turn the power off

Press the **ON/OFF** button again.



- If the “Card locked!” message appears right after the power is turned on, the SD card cannot record (p. 22).
- The Date/Time menu will appear the first time the camera power is turned on or whenever the built-in rechargeable lithium-ion battery charge is low. Reset the date and time when this occurs (p. 27).
- If the power saving function activates, press the **ON/OFF** button to restore power (p. 33).
- You will hear a start-up sound and see the start-up image when the power is turned on. (To change the start-up sound and image, see pp. 53, 128.)
- The start-up image does not display when the camera is connected to a TV via the A/V OUT terminal.

#### Turning On the Power without the Start-Up Sound

Hold the **MENU** button while pressing the ON/OFF button. This will set the Mute setting to On and silence the operation sound and the shutter sound. This is convenient when you wish to shoot silently.

## Power Saving Function

This camera is equipped with a power saving function.

When this function is turned on and it activates, restore power by pressing the **ON/OFF** button.

**Shooting Mode:** Powers down approximately 3 minutes after the last control is accessed on the camera.  
The LCD monitor automatically turns off 1 minute\* after the last control is accessed even if [Auto Power Down] is set to [Off]. (Press any button other than the **ON/OFF** button or change the camera orientation to turn the LCD monitor back on.)

\* This time can be changed (p. 51).

**Playback Mode:** Powers down approximately 5 minutes after the last control is accessed on the camera.

**Connected to a Printer (sold separately):**

Powers down approximately 5 minutes after the last control is accessed on the camera.

- The power saving function will not activate during auto play or while the camera is connected to a computer.
- The power saving function can be turned off (p. 51).

## Switching Between Shooting/Playback

The mode switch is used to select Shooting and Playback functions.

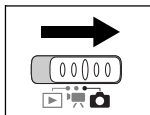

### To Shoot Still Images (Shooting Mode)

Slide the mode switch to .

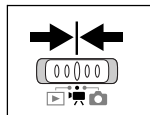



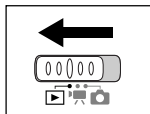

### To Shoot Movies (Movie Mode)

Slide the mode switch to .





### To Play Back Images (Playback Mode)



Slide the mode switch to .

- The lens retracts approximately 1 minute after changing the mode switch position from  or  to .
- When a printer is connected, images can be printed (see the *Direct Print User Guide*).
- When a camera is connected, recorded images can be downloaded to and viewed with a computer (p. 119).



- When a printer is properly connected, the ,  or  icon appears on the LCD monitor.

## Using the LCD Monitor

The LCD monitor can be used to compose images while shooting, adjust menu settings and play back recorded images. Icons showing the camera's status and setting contents appear on the LCD monitor. You can change the information display contents using  in the  (Set up) menu.



The image in the LCD monitor will darken in strong sunlight or bright light. This does not constitute a malfunction.

### Shooting Information (Shooting Mode)

[Off]



[On]



### Review Information (Review of an Image Right After It Is Shot)

[Off]



[On]



### Replay Information (Playback Mode)

[Off]























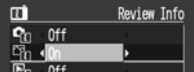

[Standard]



[Detailed]



## How to Change the Information Displayed on the LCD Monitor

	<b>1</b> Press the <b>ON/OFF</b> button until the indicator blinks green.
	<b>2</b> Press the <b>MENU</b> button. The  (Rec.) or  (Play) menu is displayed.
 	<b>3</b> In the  (Set up) menu, Select  and press the <b>SET</b> button.
   	<b>4</b> Use the  or  button to select  ,  or  and use the  or  button to select the contents you wish to set.  ( <b>Shooting Info</b> ) Select [Off] or [On].  ( <b>Review Info</b> ) Select [Off] or [On].  ( <b>Replay Info</b> ) Select [Off], [Standard] or [Detailed].
	<b>5</b> Press the <b>MENU</b> button. The display will return to the Menu display. Press the <b>MENU</b> button again to return to the shooting or playback screen.



- The LCD monitor settings are saved by the camera when the power is turned off so that the same settings are automatically available when the power is turned on again.
- In Index playback mode (p. 93), the detailed display is not available.



## Information Displayed on the LCD Monitor

When shooting or playing back images, the shooting information, review information or replay information appears on the LCD monitor.

### Shooting Information (Shooting Mode)

When setting the flash, continuous mode or self-timer, the shooting information displays on the LCD monitor for approximately 6 seconds even if [Shooting Info] is set to [Off]. (It may not display under some circumstances, depending on the selected settings.)



A slow shutter speed has likely been selected because of insufficient lighting if the indicator blinks orange after the metering preparations are complete and the camera shake icon  displays in the LCD monitor. Set the flash to  or , or affix the camera to a tripod to shoot.

\*  
Low Battery (p. 21)

[ ]\*  
Spot AE Point Frame  
( and Mode)

\*  
AF Frame (p. 75)



Quick Shot (p. 44)

Shooting Method (pp. 65, 68)

Flash (p. 60)

Auto Rotate (p. 88)

\*  
Movie Recording (p. 70)

1.3x 1.6x 2.0x 2.5x 3.1x 4.1x  
5.1x 6.5x  
Zoom Magnification\* (p. 42)  
(Zoom powers appear when the  
digital zoom is activated.)

Shots Remaining or Remaining  
Movie Time (sec.)

\*  
Shooting Mode (p. 62)

-2...+2  
Exposure Compensation (p. 79)

1" ... 15"  
Long Shutter Mode (p. 80)

White Balance (p. 82)

ISO Speed (p. 87)

Photo Effect (p. 86)

Metering Mode (p. 78)

Compression (p. 58)

Resolution (p. 58)

\*  
Camera Shake Warning (p. 37)

\* Appears even if [Shooting Info] is set to [Off].



## Review Information (Review of an Image Right After It Is Shot)

Right after a shot is taken, the image and its information appears in the LCD monitor for 2 seconds (or for the number of seconds selected if the review time was changed) even if you release the shutter button (p. 56). If you continue to press the shutter button right after shooting an image, or press the **SET** button while the image is displayed, the image will continue to display.

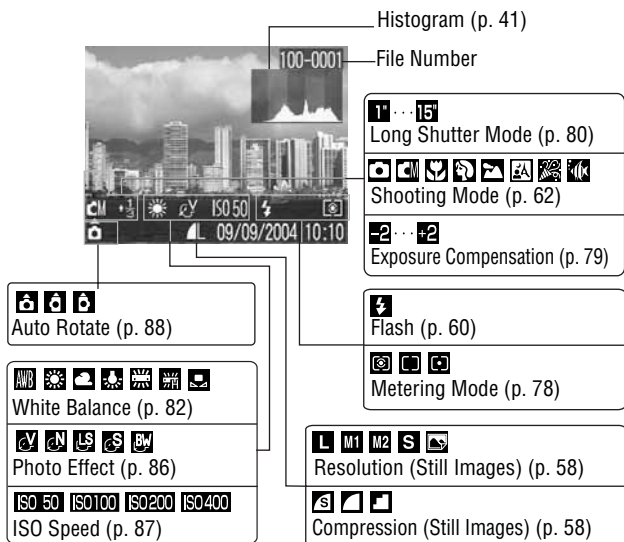

## Replay Information—Standard (Playback Mode)



100-0001 — File Number

Image Number — 1/10

09/09/2004 10:10 — Shooting Date

**Ⓚ**  
Protection Status (p. 103)

**🎵**  
WAVE Format Sound (p. 100)

**L M1 M2 S**  
Resolution (Still Images) (p. 58)

**AVI**  
Movie (p. 94)

**Ⓢ**  
Compression (Still Images) (p. 58)

## Replay Information—Detailed (Playback Mode)



Histogram

100-0001

**1' ... 15'**  
Long Shutter Mode (p. 80)

**📷 📺 🎵 🎧 📶 📡 📢 📣**  
Shooting Mode (p.62, 70, 72)

**-2 ... +2**  
Exposure Compensation (p. 79)

**AWB ☀️ ☁️ 🌧️ 🌩️ 🌪️ 🌈**  
White Balance (p. 82)

**📷 📺 📷 📷 📷**  
Photo Effect (p. 86)

**ISO 50 ISO100 ISO200 ISO400**  
ISO Speed (p. 87)





**1640 1320 1160**  
Resolution (Movies) (p. 58)

**🔋**  
Flash (p. 60)

**📷 📺 📷**  
Metering Mode (p. 78)

Movie Length Shown on Movie Files (p. 70)

The following information may also be displayed with some images.

	A sound file in a format other than the WAVE format is attached or the file format is not recognized.
	JPEG file with format not conforming to Design rule for Camera File System Standards
	RAW format file
	File with unrecognized format



Please note that image information recorded by this camera may not display correctly on other cameras and image information recorded by other cameras may not display correctly on this camera.

## Histogram Function

The histogram is a graph that allows you to judge the brightness of the shot image. The greater the bias toward the left in the graph, the darker the image. The greater the bias toward the right, the brighter the image. If the image is too dark, adjust the exposure compensation to a positive value. Similarly, adjust the exposure compensation to a negative value if the image is too bright (p. 79).

### Sample Histograms



**Dark Image**



**Balanced Image**





**Bright Image**

## Using the Digital Zoom

When using the digital zoom, images can be zoomed to approximately 1.3x, 1.6x, 2.0x, 2.5x, 3.1x, 4.1x, 5.1x or 6.5x.



### 1 Press the button.

- The magnification factor appears in the upper right corner of the LCD monitor.
- Press the  button again to further zoom the image.
- Press the  button to zoom out.



- Shoot while the magnification factor display is blue for prints up to the postcard print size. This will allow you to obtain optimal print quality.
- Images become coarser the more they are digitally zoomed. However, the actual recorded image is not as coarse as it appears in the LCD monitor.
- You can set the camera to prohibit digital zooming (p. 49).

## Pressing the Shutter Button

The shutter button features a two-stage action. You can also shoot images with a single press of the shutter button without pressing it halfway first (Quick Shot).

### 1. Pressing Halfway

Pressing halfway automatically sets the exposure, focus and white balance.

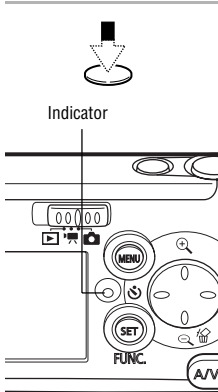

#### Press the shutter button halfway.

- **Beep**
  - Focused: 2 beeps
  - Focusing difficulty: 1 beep
- **Indicator Status**
  - Green: Metering complete
  - Orange: Flash will fire
  - Blinking Orange: Camera shake warning/  
Insufficient exposure

#### ● **AF Frame Status**

##### **AiAF On (p. 75)**

- Green Frame: Metering complete  
(focused AF frame)
- No Frame: Focusing difficulty

##### **AiAF Off (p. 75) (Center AF Frame)**

- Green Frame: Metering complete
- Yellow Frame: Focusing difficulty

### 2. Pressing Fully

Pressing the shutter button down fully activates the shutter and causes the shutter sound to sound.





#### Press the shutter button fully.

While the image is being recorded to the SD card, the indicator blinks green.



Shots cannot be taken while the flash is charging.

### AF-assist Beam

- The AF-assist Beam will sometimes emit when the shutter button is pressed halfway to assist focusing in certain conditions, e.g., dark conditions.
- The AF-assist Beam can be turned off (p. 49).  
For example, if animals are your subject, turn off the beam when shooting in the dark to avoid startling them.  
However, please keep in mind the following facts.
  - Turning the AF-assist Beam off or shooting in dark places may make it more difficult for the camera to focus.
  - The red-eye reduction lamp may emit when the flash is set to  or  even if the AF-assist Beam is turned off.

### Quick Shot

By pressing the shutter button fully without stopping mid-way, you can shoot certain pictures you might have missed otherwise.

- Confirm that  appears on the LCD monitor before using the Quick Shot function (p. 49).
- Hold the camera firmly with both hands since camera shake may become a factor.
- It may be impossible to focus on subjects that are closer than approximately 1.5 meters (4.9 ft.). If this happens, press the shutter button halfway to focus and shoot the image.

### About the Autofocus Function









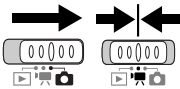

This camera employs AiAF (artificial intelligence autofocus) technology which uses a broad metering field to calculate the focal distance with high precision. It delivers a crisp focus even when the photographic subject is slightly off-center.

The AiAF function can be turned off so that the autofocus is metered from a fixed AF frame at the center of the field (p. 75).

## Selecting Menus and Settings

Menus are used to adjust shooting and playback settings, as well as other camera settings like the Date/Time and sounds. Menus are displayed by pressing the **SET/FUNC.** or **MENU** button according to the circumstances. Use the following procedures to select settings.

### Selecting Menu Settings with the SET/FUNC. Button (Shooting Mode only)

	<p><b>1</b> Slide the mode switch to  (Shooting) or  (Movie).</p>
 <p>SET FUNC.</p>	<p><b>2</b> Press the SET/FUNC. button.</p>
	<p><b>3</b> Use the  or  button to select an item.</p> <p>Please see the <i>FUNC. Menu</i> topic on the next page for the selectable menu items.</p>
	<p><b>4</b> Use the  or  button to select an option.</p> <ul style="list-style-type: none"> <li>• Some menu items allow you to make further settings by pressing the <b>MENU</b> button.</li> <li>• You can shoot right after performing these steps. The menu displays again after the shot, allowing you to change the settings easily.</li> </ul>
 <p>SET FUNC.</p>	<p><b>5</b> Press the SET/FUNC. button.</p>

## FUNC. Menu

() Shooting Mode (p. 62)



() Photo Effect (p. 86)

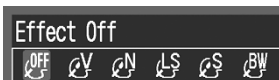

() Exposure Compensation (p. 79)



() Metering Mode (p. 78)



() Long Shutter Mode (p. 80)



() Compression (p. 58)



() White Balance (p. 82)



() Resolution (p. 58)



() ISO Speed (p. 87)







() Resolution (Movie) (p. 58)



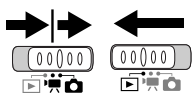









( ) Items in parentheses show default settings.

## Selecting Menu Settings with the MENU Button



**1** Slide the mode switch to  (Shooting),  (Movie) or  (Playback).



	<p><b>2 Press the MENU button.</b></p> <p>In Shooting mode, the  (Rec.) menu appears. In Playback mode, the  (Play) menu appears.</p>
	<p><b>3 Use the ◀ or ▶ button to select the Rec./Play, Set up, or My Camera menu.</b></p> <p>Select the menu with the  / ,  or  icon in the upper left corner of the LCD monitor selected.</p>
	<p><b>4 Use the ▲ or ▼ button to select an item.</b></p> <p>See <i>Menu Settings and Factory Defaults</i> (p. 49).</p>
	<p><b>5 Use the ◀ or ▶ button to select an option.</b></p> <p>Menu items followed by an ellipsis (...) can only be selected after pressing the <b>SET/FUNC.</b> button or the ▶ button to display the next menu. Press the <b>SET/FUNC.</b> or <b>MENU</b> button again to confirm the setting.</p>
	<p><b>6 Press the MENU button.</b></p> <ul style="list-style-type: none"> <li>• The menu will close.</li> <li>• In Shooting mode, the menu can be closed by pressing the shutter button halfway.</li> </ul>



See *Setting the DPOF Print Settings* for the procedures for the  (Print Order) item in the Play menu.

## Shooting Mode

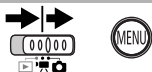

## Playback Mode



### Rec. Menu



(The menu will appear slightly different depending on the Shooting mode)

### Play Menu



### Set up Menu

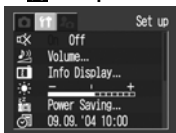

### My Camera Menu



- When the My Camera menu is displayed, pressing the button restores the Rec./Play menu.
- When the Rec./Play menu is displayed, pressing the button displays the My camera menu.

Shooting Mode

Playback Mode

: Selects items.

: Selects options.















## Menu Settings and Factory Defaults







This chart shows the options and default settings for each menu.

\* Default setting







### Rec. Menu













Menu Item	Options	Reference Page
 <b>Quick Shot</b>	Sets the Quick Shot option to on or off. <ul style="list-style-type: none"><li>• On*</li><li>• Off</li></ul>	p. 44
 <b>AiAF</b>	Sets whether or not the camera automatically selects the AF frame or a fixed center AF frame. <ul style="list-style-type: none"><li>• On*</li><li>• Off</li></ul>	p. 75
 <b>Self-timer</b>	Sets the duration of the self-timer delay. <ul style="list-style-type: none"><li>•  10 seconds*</li><li>•  2 seconds</li></ul>	p. 68
 <b>AF-assist Beam</b>	Sets the AF-assist Beam to on or off. <ul style="list-style-type: none"><li>• On*</li><li>• Off</li></ul>	p. 44
 <b>Digital Zoom</b>	Sets the digital zoom to on or off. <ul style="list-style-type: none"><li>• On*</li><li>• Off</li></ul>	p. 42
 <b>Review</b>	Sets the duration images display on the LCD monitor after the shutter button releases. <ul style="list-style-type: none"><li>• Off</li><li>• 2* to 10 seconds</li></ul>	p. 56
 <b>Date Stamp</b>	Sets the date stamp for postcard prints with embedded date stamps. <ul style="list-style-type: none"><li>• Off*</li><li>• Date</li><li>• Date &amp; Time</li></ul>	p. 67
 <b>Long Shutter</b>	Sets the shutter speed to slow settings. <ul style="list-style-type: none"><li>• On</li><li>• Off*</li></ul>	p. 80
 <b>Stitch Assist</b>	Images are shot in overlapping series to create single panoramic images. <ul style="list-style-type: none"><li>•  Left to right*</li><li>•  Right to left</li></ul>	p. 72







## Play Menu

Menu Item	Options	Reference Page
 <b>Protect</b>	Protects images from accidental erasure.	p. 103
 <b>Rotate</b>	Rotates images clockwise 90° or 270° in the display.	p. 98
 <b>Sound Memo</b>	Adds sound memos to images.	p. 99
 <b>Erase all</b>	Deletes all images from an SD card (except for protected images).	p. 105
 <b>Auto Play</b>	Plays images automatically one after the other.	p. 102
 <b>Print Order</b>	Selects images and the number of print copies for output to a direct print compatible printer or photo developing service.	p. 108
 <b>Transfer Order</b>	Specifies settings for images before downloading to a computer.	p. 114

## Set up Menu



Menu Item	Options	Reference Page
 <b>Mute</b>	Set to On to silence the start-up, shutter, operation and self-timer sounds all at once. See <i>How the [Mute] option in the  (Set up) Menu and Sounds in the  (My Camera) Menu Interact</i> (p. 53). <ul style="list-style-type: none"> <li>• On</li> <li>• Off*</li> </ul> (Still beeps to warn of an error even when set to On.)	–
 <b>Volume</b>	Adjusts the volume of the start-up sound, operation sound, self-timer sound, shutter sound and playback sound. The volume cannot be adjusted if [Mute] is set to [On].  <div style="text-align: center;">  </div> Off 1 2* 3 4 5	–
 <b>Start-up Vol.</b>	Adjusts the volume of the start-up sound when the camera power is turned on.	p. 32

Menu Item	Options	Reference Page
 <b>Operation Vol.</b>	Adjusts the volume of the operation sound that beeps when any button other than the shutter button is pressed.	—
 <b>Selftimer Vol.</b>	Adjusts the volume of the self-timer sound played 2 sec. before the shutter is released.	p. 68
 <b>Shutter Volume</b>	Adjusts the volume of the sound played when the shutter releases. The shutter sound does not play when a movie is recording.	p. 43
 <b>Playback Vol.</b>	Adjusts the volume of movie sounds and sound memos.	p. 94 p. 99
 <b>Info Display</b>	Switches between display modes for the Shooting Info, Review Info and Replay Info options.	p. 35
 <b>Shooting Info</b>	• On •Off*	
 <b>Review Info</b>	• On •Off*	
 <b>Replay Info</b>	• Detailed •Standard •Off*	
 <b>LCD Brightness</b>	Adjusts the LCD brightness of the LCD monitor. • -7 to 0* to +7 Use the ◀ or ▶ button to adjust the brightness. If you press the ▲ or ▼ button, the display returns to the Set up menu. You can check the brightness in the LCD monitor while you are adjusting the setting.	—
 <b>Power Saving</b>	Sets the [Auto Power Down] and [Display Off] options.	p. 33
 <b>Auto Power Down</b>	Sets whether or not the camera automatically powers down after a set period of time elapses without something being pressed. • On* • Off	
 <b>Display Off</b>	Sets the length of time before the LCD monitor goes off when no camera operation is performed. • 10 sec. • 20 sec. • 30 sec. • 1 min.* • 2 min. • 3 min.	
 <b>Date/Time</b>	Sets the date and time and the date format.	p. 27











Menu Item	Options	Reference Page
 <b>Clock Display</b>	Sets the length of time for which the clock displays. • 0 – 5* – 10 sec. • 20 sec. • 30 sec. • 1 min. • 2 min. • 3 min.	p. 29
 <b>Format</b>	Formats (initializes) SD cards.	p. 24
 <b>File No. Reset</b>	Sets how file numbers are assigned to images when new SD cards are inserted. • On • Off*	p. 89
 <b>Auto Rotate</b>	Sets whether or not images shot with the camera held vertically are automatically rotated in the display. • On* • Off	p. 88
 <b>Language</b>	Sets the language used in menus and messages on the LCD monitor. • English* • Deutsch (German) • Русский (Russian) • Français (French) • Português (Portuguese) • Nederlands (Dutch) • Ελληνικά (Greek) • Dansk (Danish) • Polski (Polish) • Suomi (Finnish) • Čeština (Czech) • Italiano (Italian) • Magyar (Hungarian) • Norsk (Norwegian) • Türkçe (Turkish) • Svenska (Swedish) • 繁體中文 • Español (Spanish) (Traditional Chinese) • 简体中文 (Simplified Chinese) • 한국어 (Korean) • 日本語 (Japanese) You can also change the language in playback mode by holding the <b>SET</b> button and pressing the <b>MENU</b> button.	p. 30
 <b>Video System</b>	Sets the video output signal standard. • NTSC • PAL	p. 127

## My Camera Menu

You can select the theme, start-up image and sound, shutter sound, operation sound and self-timer sound used on this camera.

These are called the My Camera settings. You can also customize the  and  options for each item with images recorded on the SD card and newly recorded sounds or by using the supplied software.

See the *Software Starter Guide* for details.





Menu Item	Available Settings	Reference Page
 <b>Theme</b>	Selects a common theme for each My Camera settings item.	p. 128
 <b>Start-up Image</b>	Sets the image displayed when the camera power is turned on.	
 <b>Start-up Sound</b>	Sets the sound emitted when the camera power is turned on.	
 <b>Operation Sound</b>	Sets the sound emitted when any button other than the shutter button is pressed.	
 <b>Selftimer Sound</b>	Sets the sound emitted 2 seconds before the shutter releases in self-timer mode.	
 <b>Shutter Sound</b>	Sets the sound emitted when the shutter button is pressed. There is no shutter sound for movies.	
My Camera Menu Contents	<ul style="list-style-type: none"> <li>•  (Off)</li> <li>• </li> <li>•  *</li> <li>• </li> </ul>	

### • How the [Mute] option in the (Set up) Menu and Sounds in the (My Camera) Menu Interact

To turn off each sound, such as the start-up sound, shutter sound, operation sound and self-timer sound, [Mute] must first be set to [On] in the  (Set up) menu. When [Mute] is set to [On], each sound option will not sound even if they are set individually to [On]. The warning sound, however, will emit even when [Mute] is set to [On].

## Resetting Settings to Their Default Values

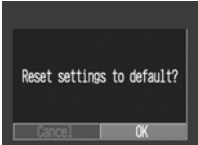
You can reset the menu and button settings to the default settings in one operation.

	<b>1 Press the ON/OFF button.</b> Set the mode switch to any position.
	<b>2 Press and hold the MENU button for more than 5 seconds.</b>
  	<b>3 Use the ◀ or ▶ button to select [OK] and press the SET button.</b> To exit without resetting, select [Cancel].



- Settings cannot be reset when the camera is connected to a computer or to a printer.
- The following cannot be reset.
  - Shooting mode
  - The Date/Time, Language and Video System options in the  (Set up) menu (p. 51, p. 52)
  - White balance data recorded with the custom white balance function (p. 82)
  - Newly added My Camera settings (p. 130)



## Shooting in Auto Mode



Shooting Mode



In this mode, all you have to do is press the shutter button and let the camera do everything else.

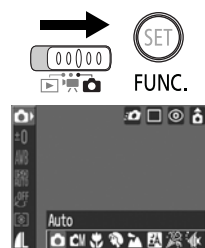

- Slide the mode switch to (Shooting). In the FUNC. menu, select (Auto).**

- See *Selecting Menus and Settings* (p. 45).
- You can shoot right after selecting an option. The menu displays again after the shot, allowing you to change the settings easily.



- Press the SET/FUNC. button.**

The display will return to the shooting screen and will appear on the LCD monitor.

- Aim the camera at the subject.**

- Press the shutter button halfway (p. 43).**



- Two beeps will sound when the camera has finished metering, and the upper indicator beside the viewfinder will light green or orange. If the LCD monitor is on, the AF frame will appear green.
- If the subject is difficult to focus on, a single beep will sound.

- Press the shutter button fully (p. 43).**



- You will hear the sound of the shutter when the shutter activates.
- The picture appears for two seconds on the LCD monitor.



- See *Functions Available in Each Shooting Mode* (p. 160).
- With the Review function, you can change the length of time images show on the LCD monitor after shooting, or set it so they do not show at all (p. 56).

## Reviewing an Image Right after Shooting

Shooting Mode



Right after a shot is taken, the image appears in the LCD monitor for 2 seconds. In addition, the images will keep on displaying regardless of the review duration setting if one of the following operations is performed.

- **Keeping the shutter button pressed after a shot.**
- **Pressing the SET/FUNC. button while the image is displayed on the LCD monitor. (It will not operate in the  mode.)**

Press the shutter button halfway to stop displaying it so that you can shoot the next frame.





- You can do the following while the image is displayed. (It will not operate in the  mode.)
  - Display the image's review information (p. 37).
  - Erase the image (p. 104).
  - After pressing the **SET/FUNC.** button, magnify the image (p. 92).

## Changing the Review Duration

The default review time is 2 seconds. The review function can be set to [Off] or changed to any time in the range of 2 to 10 seconds in one-second increments.



**1** In the  (Rec.) menu, select .

See *Selecting Menus and Settings* (p. 45).



## 2 Use the ◀ or ▶ button to select the review setting and press the MENU button.





- With the [Off] option, the image will not automatically display.
- In the [2 sec.] to [10 sec.] range, the image will continue to display for the specified time even if the shutter button is released.

## Changing Resolution/Compression Settings





Shooting Mode





You can change the compression (excluding movies) and resolution settings to suit the purpose of the image you are about to shoot.

Resolution		Purpose
<b>L</b> (Large) 2592 x 1944 pixels	Large   Small	<ul style="list-style-type: none"> <li>• Print larger than A4-size prints* 210 x 297 mm (8.3 x 11.7 in.)</li> <li>• Print larger than Letter-size prints* 216 x 279 mm (8.5 x 11 in.)</li> </ul>
<b>M1</b> (Medium 1) 2048 x 1536 pixels		<ul style="list-style-type: none"> <li>• Print up to A4-size prints* 210 x 297 mm (8.3 x 11.7 in.)</li> <li>• Print up to Letter-size prints* 216 x 279 mm (8.5 x 11 in.)</li> </ul>
<b>M2</b> (Medium 2) 1600 x 1200 pixels		<ul style="list-style-type: none"> <li>• Print postcard-size prints 148 x 100 mm (6 x 4 in.)</li> <li>• Print L-size prints 119 x 89 mm (4.7 x 3.5 in.)</li> </ul>
<b>S</b> (Small) 640 x 480 pixels		<ul style="list-style-type: none"> <li>• Send images as e-mail attachments</li> <li>• Shoot more images</li> </ul>
  (Postcard Date Imprint Mode) 1600 x 1200 pixels		<ul style="list-style-type: none"> <li>• The resolution is set to <b>M2</b> (1600 x 1200) and the compression to  (Fine).</li> <li>• See <i>Postcard Date Imprint Mode</i> (p. 66).</li> </ul>

\* Paper sizes vary according to region.

Compression		Purpose
 <b>Superfine</b>	High Quality   Normal	• Shoot higher quality images
 <b>Fine</b>		• Shoot normal quality images
 <b>Normal</b>		• Shoot more images

Movies can be shot with the following resolutions.

Resolution	
 640	640 x 480 pixels
 320	320 x 240 pixels
 160	160 x 120 pixels

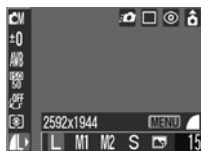

- 1** In the **FUNC.** menu, select **[L]**\* and then use the **MENU** button to select **[L]**\* or **[M1]**\*.

See *Selecting Menus and Settings* (p. 45).

\* The current setting is displayed.



- 2** Use the **◀** or **▶** button to select an option.

#### Resolution (Still Images)

Select **[L]**, **[M1]**, **[M2]**, **[S]** or **[CAM]**.

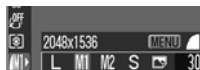

#### Resolution (Movies)

Select **[640]**, **[320]** or **[160]**.



#### Compression (Excluding Movies)

Select **[S]**, **[M1]** or **[M2]**.



You can shoot right after selecting an option. The menu displays again after the shot, allowing you to change the settings easily.



**FUNC.**

- 3** Press the **SET/FUNC.** button.

The display will return to the shooting screen.



- See *Image File Sizes (Estimated)* (p. 146).
- See *SD Cards and Estimated Capacities* (p. 145).

## ⚡ Using the Flash



Shooting Mode



Use the flash according to the guidelines below.

	<b>Auto</b>	The flash fires automatically as required by the light level.
	<b>Auto with red-eye reduction</b>	The flash fires automatically as required by the lighting level, and the red-eye reduction lamp fires each time the main flash fires.
	<b>Flash on with red-eye reduction</b>	The flash and red-eye reduction lamp fire with each shot.
	<b>Flash on</b>	The flash fires with every shot.
	<b>Flash off</b>	The flash will not fire.
	<b>Slow Synchro</b>	The flash timing is adjusted to slow shutter speeds. This reduces the chance that the background will be dark when shots are taken at night or in rooms with artificial lighting. The red-eye reduction lamp fires with each shot. Use of a tripod is recommended.

	○	○	—	○	○	○	○	○	○	○	○	○	○	—
	○	○	—	○	○	○	○	○	○	○	○	○	○	—
	—	—	—	○	○	○	○	○	○	○	○	○	○	—
	—	○	—	○	○	○	○	○	○	○	○	○	○	△
	○	○	○	○	○	○	○	○	○	○	○	○	○	△
	—	○	—	—	—	—	—	—	—	—	—	—	—	△

○ Setting available











△ Can be selected for the first image only.



### 1 Press the ⚡ button to switch between flash modes.

The selected flash mode appears on the LCD monitor.





- When you use flash photography at higher ISO speeds, the chances of white streaks appearing in the image increase the closer you approach to the subject.
- Since a slow shutter speed is selected in dark places when the flash is set to Off or Slow Synchro, take care to avoid blurring the image.
  - Shooting in , , ,  or  mode  
Be careful to hold the camera still to avoid camera shake.
  - Shooting in , ,  or  mode  
Fix the camera to a tripod to shoot in these modes since the shutter speed will be slower than in the  mode.



- The flash can be fired when the indicator lights a steady orange after pressing the shutter button halfway.
- The flash may take up to approximately 10 seconds to charge. The recharging time will vary with such factors as the shooting conditions and battery charge. Shots cannot be taken while the flash is charging.
- The flash fires twice. The main flash follows a preparatory pre-flash. The exposure reading obtained from the subject with the pre-flash is used to set the optimal flash intensity for the main flash, which is used to capture the image.
- When using the flash for standard photography, be sure to shoot from a distance of at least 30 cm (12 in.) away from your subject.

### Red-Eye Reduction

- Light reflecting back from eyes can make them appear red when the flash is used in dark areas. Under these conditions, use the red-eye reduction mode. For this mode to be effective, the subject must be looking right at the red-eye reduction lamp. Try asking them to look directly at the lamp. Even better results can be obtained by increasing the lighting in indoor settings or approaching closer to the subject.
- The shutter will not activate for approximately 1 second after the red-eye reduction lamp fires in order to improve the effect (excluding when using the quick shot function). If you want a more immediate shutter response, set the flash to ,  or .

## Selecting a Shooting Mode



Shooting Mode



You can take an optimal picture simply by selecting the appropriate shooting mode.

	<b>Auto</b>	Leaves almost all of the settings choices up to the camera (p. 55).
	<b>Manual</b>	Lets you adjust the exposure, white balance and color effect settings yourself.
	<b>Macro</b>	You can approach as close as 3 cm (1.2 in.) to a subject to shoot (p. 64).
	<b>Portrait</b>	Use this mode when you want the subject to appear sharp and the background blur. You can also capture minute gradations in skin and hair tones for beautiful images. By composing the image with a person's upper body filling the LCD monitor, you can effectively blur the background.
	<b>Landscape</b>	Use this to record landscape scenery. You can also use it to focus on distant subjects when both close and distant objects are mixed in a composition.
	<b>Night Snapshot</b>	Use this to take snapshots of people against twilight or night backgrounds to reduce camera blur even without using a tripod.
	<b>Indoor</b>	Prevents camera shake and maintains the subject's true color when shooting under florescent or tungsten lightning. The exposure is regulated so as to avoid the use of flash as much as possible.
	<b>Underwater</b>	Appropriate for shooting images with the All Weather Case AW-DC10 (sold separately). This mode uses an optimal white balance setting to reduce bluish tones and record images with natural hues.

**Manual**



**Portrait**



**Landscape**





## Night Snapshot



## Indoor



## Underwater

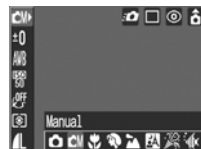

## 1 Choose a shooting mode from the FUNC. menu.



- See *Selecting Menus and Settings* (p. 45).
- You can shoot right after selecting an option. The menu displays again after the shot, allowing you to change the settings easily.





FUNC.



## 2 Press the SET/FUNC. button.

- The display will return to the shooting screen and the icon of the selected shooting mode will appear on the LCD monitor.
- Except for the  mode, the shooting procedures are the same as for *Shooting in Auto Mode* (p. 55).
- See *Shooting Close-Ups* (p. 64) for shooting in  mode.
- To shoot in  mode, refer to the *All Weather Case User Guide* that accompanies All Weather Case AW-DC10 (sold separately).



In , , and  modes, the ISO speed may increase and cause noise in the image.



- See *Functions Available in Each Shooting Mode* (p. 160).
- Results may vary depending on the subject.
- To shoot underwater, install the camera in All Weather Case AW-DC10 (sold separately).

# Shooting Close-Ups



Shooting Mode



You can shoot with the lens very close to the subject (Macro function). Subjects can be focused in the range of 3 to 10 cm (1.2 to 3.9 in.) from the front of the lens.



Be careful not to bang the lens against the subject when shooting in macro mode.

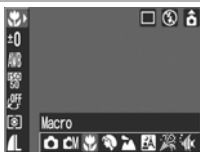

## 1 In the FUNC. menu, select

- See *Selecting Menus and Settings* (p. 45).
- You can shoot right after selecting an option. The menu displays again after the shot, allowing you to change the settings easily.



FUNC.

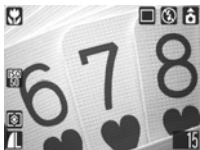

## 2 Press the SET/FUNC. button.

The display will return to the shooting screen and will appear on the LCD monitor.



- See *Functions Available in Each Shooting Mode* (p. 160).
- The recordable area for close-ups is approx. 2.4 to 1.8 cm (0.94 x 0.71 in.).

### Image Comparison

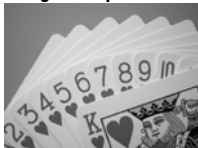

Standard  
(Subject Distance: 10 cm (3.9 in.))



Macro  
(Subject Distance: 3 cm (1.2 in.))



Digital Zoom  
(Approx. 6.5x)

## Continuous Shooting



Shooting Mode





In this mode, the camera shoots continuously at approximately 0.9 images per second\* (Large/Fine) while the shutter button is held down. Recording ceases when the shutter button is released.

\* This figure reflects standard shooting criteria established by Canon. Actual figures may vary according to the subject and shooting conditions.



**1** Press the  button to display .

### To Cancel Continuous Shooting

Press the  button twice to display .



- The interval between shots may lengthen slightly when the camera's built-in memory fills.
- If the flash is firing, the interval between shots will lengthen to accommodate the flash's charging requirements.

# Postcard Date Imprint Mode



Shooting Mode



You can shoot images with optimal resolution and compression for postcard size printing.

- When printing standard image data to postcard size, sometimes the top and bottom may not get printed.
- By shooting images in the Postcard Date Imprint mode, you can check the printing area (vertical/horizontal ratio of 3:2) beforehand. In addition, the resolution locks to **M2** (1600 x 1200) and the compression locks to the  (Fine) setting, rendering smaller file sizes.



## 1 In the FUNC. menu, select .

- See *Selecting Menus and Settings* (p. 45).
- \* The current setting is displayed.



## 2 Use the or button to select .

You can shoot the image right after selecting settings by pressing the shutter button. The menu displays again after the shot, allowing you to change the settings easily.



FUNC.



## 3 Press the SET/FUNC. button.

- The display will return to the shooting screen and  will appear on the LCD monitor.
- When you press the shutter button halfway, the area that will not get printed grays out.



Selecting  cancels the digital zoom when it is set to On.



- The  icon appears in the LCD monitor when the date stamp setting (see below) is set to Date or Date & Time.
- For printing instructions, refer to the *Direct Print User Guide*.

## Embedding the Date in the Image Data



You can embed the date on image data when  (Postcard Date Imprint Mode) is selected. The date will be printed on your images even if it has not been set at the computer or printer.



- Ensure that the camera's date/time is set beforehand (p. 27).
- You cannot embed the date in image data when  (Postcard Date Imprint Mode) is not selected.



1

In the  (Rec.) menu, select .

See *Selecting Menus and Settings* (p. 45).



2

Use the  or  button to select [Date] or [Date & Time].



- The display will return to the shooting screen.
- When you do not want to print the date, select [Off].



- The date stamp cannot be deleted from the image data once it has been set.
- A portion of the date may not print when selecting the credit card size print (54 x 86 mm(2.1 x 3.4 in)) to print on a compact photo printer (SELPHY CP series) or card photo printer.

## Using the Self-timer



Shooting Mode



With this function, images are shot 10 or 2 seconds after the shutter button is pressed. This is useful when you want to take a memorable photo with everyone including yourself in the picture. The self-timer can be used in any shooting mode.



### 1 Press the button to display or .

- When the shutter button is pressed fully, the self-timer will activate and the self-timer lamp will blink.
- When the self-timer is set to () , the shutter activates 10 (2) seconds after the shutter button is pressed fully.

### To Cancel the Self-Timer

Press the button to display .

## Changing the Self-timer Countdown Time



- 1** In the (Rec.) menu, select . See *Selecting Menus and Settings* (p. 45).



- 2** Use the or button to select or and press the MENU button.

- The display will return to the shooting screen.
- When is selected, the self-timer sounds and the blinking gets faster 2 seconds before the shutter activates.
- When is selected, the self-timer sounds at the same time as the shutter button is pressed. The shutter activates in 2 seconds.



- The self-timer sound can be changed with the Selftimer Sound item in the (My Camera) menu (p. 53).
- See *Photo Tips and Information* (p. 148).

## Shooting a Movie



The resolution can be set to either **[640]** (640 x 480), **[320]** (320 x 240) or **[160]** (160 x 120) (p. 58).



### 1 Slide the mode switch to **Movie**.

The maximum recording time (in seconds) is displayed.



### 2 Press the shutter button fully.

- Shooting and sound recording starts simultaneously.
- During shooting the recording time (in seconds) and a red circle appear on the LCD monitor.



### 3 Press the shutter button fully again to stop recording.

- The maximum length of a movie clip (at 10 frames/sec. (**[640]**), 15 frames/sec. (**[320]** **[160]**)) is 30 sec. (**[640]**) or 3 min. (**[320]** **[160]**).  
(according to Canon's standardized tests).  
\* Recording times may vary between SD cards.  
See *SD Cards and Estimated Capacities* (p. 145).
- The maximum length of movies may vary with the subject and shooting conditions. Recording will automatically stop when the maximum is reached or when the SD card runs out of free capacity.





- The recording time may not display properly during shooting or filming may stop unexpectedly with the following types of SD cards.
  - Slow recording cards
  - Cards formatted on a different camera or a computer
  - Cards which have had images recorded and erased repeatedlyAlthough the recording time may not display properly during shooting, the movie will be recorded correctly on the SD card. Recording time will display properly if you format the SD card in this camera (excluding slow recording SD cards).
- You are recommended to use an SD card that has been formatted in your camera to shoot movies (p. 24). The card supplied with the camera may be used without further formatting. When shooting movies at **640** (640 x 480), you are recommended to use the separately sold SDC-128M SD card (not sold in some regions) or SDC-512MSH SD card (not sold in some regions).
- Be careful not to touch the microphone while recording.
- Do not press buttons other than the shutter button while filming to avoid inadvertent recording of the operation sounds.
- The AE, AF and white balance settings remain fixed for subsequent frames at the values selected for the first frame.
- After a clip is shot, the indicator will blink green while the clip is being written to the SD card. You cannot shoot again until the blinking stops.



- See *Functions Available in Each Shooting Mode* (p. 160).
- Sound is recorded monaurally.
- There is no shutter sound in movie mode.
- QuickTime 3.0 or later is required to play back movie files (AVI/Motion JPEG) on a computer. QuickTime (for Windows) is included on the Canon Digital Camera Solution Disk. On the Macintosh platform, this program is generally bundled with Mac OS 8.5 or later operating systems.

## Shooting Panoramic Images (Stitch Assist)

Shooting Mode



Stitch Assist can be used to shoot overlapping images that can later be merged (stitched) to create one panoramic image on a computer.

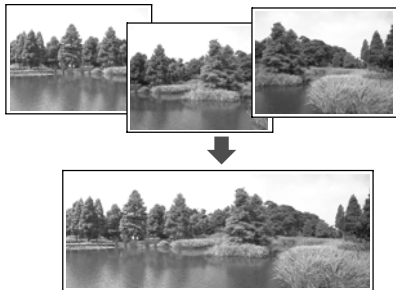

The overlapping seams of several adjacent images can be joined into a single panoramic image.



To merge the images on a computer, use PhotoStitch, one of the supplied programs.

### Framing a Subject

The PhotoStitch program detects the overlapping portions of adjoining images and merges them. When shooting, try to include a distinctive item (landmark) in the overlapping portions.





- Compose each frame so that it overlaps 30 - 50% of the adjoining image. Try to keep the vertical misalignment to less than 10% of the image height.
- Do not include moving items in the overlap.
- Do not try to stitch images that include both distant and close items. These items may appear warped or doubled up in the merged image.
- Make the brightness in each image consistent. The final image will appear unnatural if the contrast in brightness is too great.
- To shoot landscapes, swivel (pan) the camera around its own vertical axis.

- To shoot close-ups, slide the camera over the subject, keeping it parallel to the subject as you move it.

## Shooting

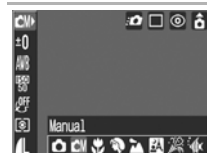

Images can be shot in two sequences in Stitch Assist mode.

	Left to right horizontally
	Right to left horizontally



- 1** In the **FUNC.** menu select 
- See *Selecting Menus and Settings* (p. 45).



- 2** In the  (Rec.) menu, select  and press the **SET/FUNC.** button.  
See *Selecting Menus and Settings* (p. 45).



FUNC.

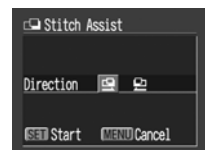

- 3** Use the  or  button to select a shooting direction and press the **SET/FUNC.** button.



FUNC.



#### 4 Shoot the first frame in the sequence.

The exposure and white balance are set and locked with the first image.



#### 5 Compose the second image so that it overlaps a portion of the first and shoot.

- Use the ◀ or ▶ button to check or retake the recorded images.
- Minor discrepancies in the overlapping portions can be corrected when the images are stitched together.



#### 6 Repeat the procedure for additional images.

A sequence may contain up to 26 images.



#### 7 Press the MENU button after the last shot.

The Stitch Assist session ends. Press the **MENU** button again to return to the shooting screen.



- A custom white balance setting cannot be set in Stitch Assist mode. To use a custom white balance setting, set it before selecting  in the Rec. menu (p. 84).
- The settings for the first image are used to take subsequent images in the sequence.
- It is not possible to display images on the TV when shooting in Stitch Assist mode.



See *Functions Available in Each Shooting Mode* (p. 160).

## Switching between Focusing Modes



Shooting Mode



Although the autofocus function is preset to the AiAF setting (9 AF frames), you can set it to the center AF frame.

When [AiAF] is set to [On], the AF frame does not appear. When [AiAF] is set to [Off], however, the AF frame will appear.

No frame	On	The camera detects the subject and highlights the AF frames, from 9 available points, that it will use to determine the focus.
<input type="checkbox"/>	Off	The camera focuses using the center AF frame. This is convenient for focusing on a specific part of a subject with greater certainty.

The  symbol represents the AF frames as they appear in the LCD monitor.



**1** In the (Rec.) menu, select .

See *Selecting Menus and Settings* (p. 45).



**2** Use the or button to select [On] or [Off].

You can shoot right after selecting an option.



**3** Press the MENU button.

The display will return to the shooting screen.



The focus is locked to the center AF frame when the digital zoom is used.

## Shooting Hard-to-Focus Subjects (Focus Lock)

Shooting Mode





It may be difficult to focus on the following types of subjects. Use the focus lock in these situations.

- Subjects with extremely low contrast to the surroundings
- Subjects with extremely bright objects at the center of the composition
- Subjects that are moving quickly
- Subjects through glass:

Try to shoot as close to the glass as possible to reduce the chances of light reflecting back off the glass.

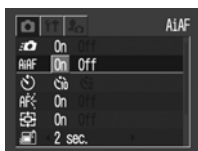
- Subjects with horizontal stripes



**1** In the  (Rec.) menu, select .

See *Selecting Menus and Settings* (p. 45).



**2** Use the  or  button to select [Off] and press the MENU button.

The display will return to the shooting screen.



**3** Aim the camera so that an object at the same focal distance as the main subject is centered in the AF frame displayed on the LCD monitor.



**4 Press the shutter button halfway and wait until two beeps sound.**

The focal distance to the object is locked.

---



**5 Re-aim the camera to compose the shot as desired and press the shutter button fully.**

---

## Switching between Light Metering Modes



Shooting Mode



You can switch between metering modes to shoot.

	<b>Evaluative</b>	Appropriate for standard shooting conditions, including backlit scenes. The camera divides images into several zones for light metering. It evaluates complex lighting conditions, such as the position of the subject, the brightness, the direct light, and the backlighting, and adjusts the settings to the correct exposure for the main subject.
	<b>Center Weighted Average</b>	Averages the light metered from the entire frame, but gives greater weight to the subject matter at the center.
	<b>Spot</b>	Meters the area within the spot AE point at the center of the LCD monitor. Use this setting when you want to set the exposure on the subject in the center of the monitor.

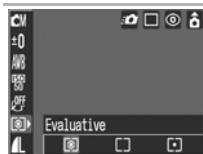

### 1 In the FUNC. menu select \*.

See *Selecting Menus and Settings* (p. 45).

\*The current setting is displayed.



### 2 Use the ◀ or ▶ button to switch between metering modes.

You can shoot right after selecting an option. The menu displays again after the shot, allowing you to change the settings easily.



FUNC.

### 3 Press the SET/FUNC. button.

The display will return to the shooting screen.



# Adjusting the Exposure Compensation



Shooting Mode



Adjust the exposure compensation setting to avoid making the subject too dark when it is backlit or shot against a bright background or to avoid making lights appear too bright in night shots.

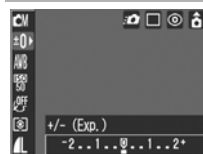

## 1 In the FUNC. menu, select $\pm 0$ \*.

See *Selecting Menus and Settings* (p. 45).

\* The current setting is displayed.



## 2 Use the ◀ or ▶ button to adjust the exposure compensation.

- The settings can be adjusted in 1/3 stops in the range -2 to +2.
- You can confirm the effect of the setting in the LCD monitor.
- You can shoot right after selecting an option. The menu displays again after the shot, allowing you to change the settings easily.



FUNC.

## 3 Press the SET/FUNC. button.

The display will return to the shooting screen.

### To Reset the Exposure Compensation

Return the setting to 0.



See *Photo Tips and Information* (p. 148).

# Shooting in Long Shutter Mode



Shooting Mode



You can set the shutter speed to a slow setting to make dark subjects appear brighter.



- 1** In the (Rec.) menu, select .  
See *Selecting Menus and Settings* (p. 45).



- 2** Use the or button to select [On] and press the MENU button.  
The display will return to the shooting screen.



- 3** In the FUNC. menu, select and press the MENU button.  
See *Selecting Menus and Settings* (p. 45).  
\* The current setting is displayed.



- 4** Use the or button to select a shutter speed.
- The higher the value, the brighter the image and the lower the value, the darker the image.
  - You can shoot right after selecting a value. The menu displays again after the shot, allowing you to change the settings easily.



FUNC.

## 5 Press the SET/FUNC. button.

The display will return to the shooting screen.



### To Cancel the Long Shutter mode

While [Long Shutter] is displayed in the FUNC. menu, press the **MENU** button.



The nature of CCD image sensors is such that noise in the recorded image increases at long shutter speeds. This camera, however, applies special processing to images shot at shutter speeds slower than 1.3 seconds to eliminate the noise, thereby producing high-quality images. Nevertheless, a certain amount of processing time may be required before the next image can be shot.



- Please note that camera shake becomes a factor at low shutter speeds. If the camera shake warning  appears on the LCD monitor, secure the camera to a tripod before shooting.
- Use of the flash may result in an over-exposed image. If that occurs, shoot with the flash set to .
- The following are unavailable:
  - Exposure Compensation
  - Light Metering
  - ISO speed: AUTO
  - Flash: Auto, Auto with Red-eye Reduction, Flash on with Red-eye Reduction

### Available Shutter Speeds

The following shutter speeds (in seconds) are available.

15 13 10 8 6 5 4 3.2 2.5 2 1.6 1.3 1

## Adjusting the Tone (White Balance)



Shooting Mode



When the white balance mode is set to match the light source, the camera reproduces colors more accurately.

Combinations of setting contents and light source are as follows.

	<b>Auto</b>	Settings are automatically set by the camera.
	<b>Day Light</b>	For recording outdoors on a bright day.
	<b>Cloudy</b>	For recording under overcast, shady or twilight skies.
	<b>Tungsten</b>	For recording under tungsten and bulb-type 3-wavelength fluorescent lighting.
	<b>Fluorescent</b>	For recording under warm-white, cool-white or warm-white (3-wavelength) fluorescent lighting.
	<b>Fluorescent H</b>	For recording under daylight fluorescent, or daylight fluorescent-type 3-wavelength fluorescent lighting.
	<b>Custom</b>	For recording with the optimal white balance data memorized in the camera from a white-colored object, such as white paper or cloth.

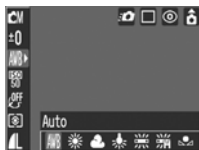

### 1 In the FUNC. menu, select **AWB** \*.

See *Selecting Menus and Settings* (p. 45).

\* The current setting is displayed.



### 2 Use the ◀ or ▶ button to select an option.

- See *Setting a Custom White Balance* (p. 84).
- You can confirm the effect of the setting in the LCD monitor.
- You can shoot right after selecting an option. The menu displays again after the shot, allowing you to change the settings easily.





FUNC.

### 3 Press the SET/FUNC. button.

The display will return to the shooting screen.



This setting cannot be adjusted when the  (Sepia) or  (B/W) photo effects are selected.

## Setting a Custom White Balance

You can set a custom white balance to obtain the optimal setting for the shooting conditions by having the camera evaluate an object, such as a piece of white paper or cloth, or a photo-quality gray card that you wish to establish as the standard white color.

In particular, take a custom white balance reading for the following situations that are difficult for the **AWB** (Auto) setting to detect correctly.

- Shooting close-ups
- Shooting subjects of monotone color (such as sky, sea or forest)
- Shooting with a peculiar source of light (such as a mercury-vapor lamp)

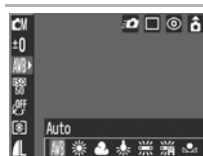

**1** In the **FUNC.** menu, select **AWB** \*.

See *Selecting Menus and Settings* (p. 45).

\* The current setting is displayed.



**2** Use the ◀ or ▶ button to select

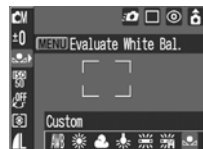



### 3 Aim the camera at the white paper, cloth or gray card and press the MENU button.

- Compose the image so the paper or cloth completely fills the center frame in the display before pressing the **MENU** button. The white data records when you press the **MENU** button. The camera reads the white balance data when you press the **MENU** button.
- You can shoot right after selecting an option. The menu displays again after the shot, allowing you to change the settings easily.



FUNC.

### 4 Press the SET/FUNC. button.

The display will return to the shooting screen.



- You are recommended to set the shooting mode to and the exposure compensation setting to zero ( $\pm 0$ ) before setting a custom white balance. The correct white balance may not be obtained when the exposure setting is incorrect (image appears completely black or white).
- Shoot with the same settings as when reading the white balance data. If the settings differ, the optimal white balance may not be set. In particular, the following should not be changed.
  - ISO Speed
  - Flash
    - Setting the flash to on or off is recommended. If the flash fires when reading the white balance data with the flash set to (Auto with Red-Eye Reduction) or (Auto), make sure that you also use the flash when you shoot.
- Since the white balance data cannot be read in Stitch Assist mode, preset the white balance before selecting in the (Rec.) menu.
- The camera will retain the manual white balance setting that you record even if you reset the camera to the default settings (p. 54).

## Changing the Photo Effect



Shooting Mode



By setting a photo effect before you shoot, you can change the look and feel of the pictures you take.

	<b>Effect Off</b>	Records normally with this setting.
	<b>Vivid</b>	Emphasizes the contrast and color saturation to record bold colors.
	<b>Neutral</b>	Tones down the contrast and color saturation to record neutral hues.
	<b>Low Sharpening</b>	Records subjects with softened outlines.
	<b>Sepia</b>	Records in sepia tones.
	<b>B/W</b>	Records in black and white.

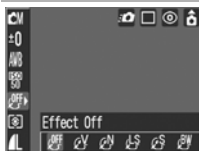

### 1 In the FUNC. menu, select \*.

See *Selecting Menus and Settings* (p. 45).

\* The current setting is displayed.



### 2 Use the ◀ or ▶ button to select an effect.

- You can confirm the photo effect in the LCD monitor.
- You can shoot right after selecting an option. The menu displays again after the shot, allowing you to change the settings easily.



FUNC.

### 3 Press the SET/FUNC. button.

The display will return to the shooting screen.



# Adjusting the ISO Speed



Shooting Mode



Raise the ISO speed when you wish to reduce the effects of camera shake, turn the flash off when shooting in a dark area, or use a fast shutter speed.

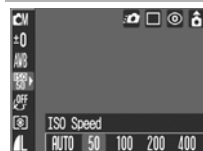

**1** In the **FUNC.** menu, select **ISO 50** \*.

See *Selecting Menus and Settings* (p. 45).

\* The current setting is displayed.



**2** Use the **◀** or **▶** button to select a speed.

You can shoot right after selecting an option. The menu displays again after the shot, allowing you to change the settings easily.



FUNC.

**3** Press the **SET/FUNC.** button.

The display will return to the shooting screen.



- Higher ISO speeds increase image noise. To take clean images, use as low an ISO speed as possible.
- The AUTO setting selects the optimal speed. It will automatically raise the speed when the light from the flash is insufficient to illuminate the subject matter.



See *Photo Tips and Information* (p. 148).





## Resetting the File Number



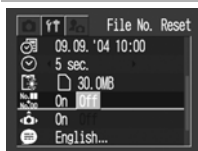

The images you shoot are automatically assigned file numbers. You can select how the file number is assigned.

On	The file number is reset to the start (100-0001) each time a new SD card is inserted. New images recorded on SD cards with existing files are assigned the next available number.
Off	The file number of the last image to be shot is memorized so that images recorded to a new SD card start from the next number.



- 1 In the  (Set up) menu, select .**  
See *Selecting Menus and Settings* (p. 45).



- 2 Use the  or  button to select [On] or [Off] and press the MENU button.**

The display will return to the shooting screen.



Setting the File No. Reset to [Off] is useful for avoiding file name duplication when images are downloaded to a computer.

## About File Numbers and Folder Numbers

Images are assigned file numbers from 0001 to 9900, and folders are assigned folder numbers from 100 to 998 (Folder numbers cannot contain 99 in the last two digits).

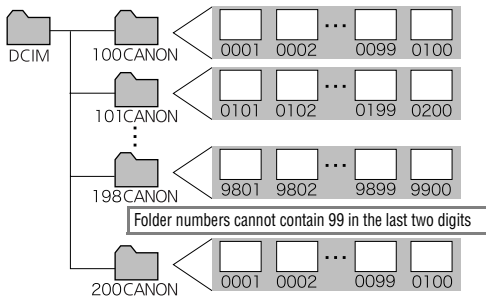

## Folder File Capacity

Each folder usually contains up to 100 images.

However, since images shot in continuous shooting and Stitch Assist mode are always saved into the same folder, a folder may contain more than 100 images. The number of images may also exceed 100 if a folder contains images copied from a computer or images shot with other cameras. Please note, however, that the images in folders containing 2001 or more images cannot be played back in this camera.

## Displaying Images Individually





### 1 Slide the mode switch to (Playback).

The last recorded image will appear in the display (single image playback).



### 2 Use the or button to move between the images.

Use the  button to move to the previous image and the  button to move the next image.

Holding the button down advances the images more rapidly, but the images will not appear as clearly.



## 1 Press the **⊕** button.

- **SET** appears on the monitor, indicating you can further magnify the image (up to approx. 10 times) by holding down the **⊕** button.
- When you press the **◀** or **▶** button, you can display the next or previous image at the same magnification.



Approximate Location  
of the Magnified Area



## 2 Press the **SET** button.

**SET** appears on the monitor, indicating you can scroll the magnified image using the **▲**, **▼**, **◀** or **▶** button to move around the image.

### To Cancel the Magnified Display

Press the **MENU** button to return to the normal display.



Movie frames and index playback images cannot be magnified.

## Viewing Images in Sets of Nine (Index Playback)



Selected Image



Movie

### 1 Hold down the SET button.

Nine images appear at a time.



### 2 Use the ▲, ▼, ◀ or ▶ button to change the image selection.

#### To Return to Single Image Playback

Hold down the SET button.

# Viewing Movies



You can play movie clips shot in mode.



Movies cannot be played in the index playback mode.



## 1 Use the or button to select a movie.

Images with a **SET** icon are movies.



Movie Control Panel      Volume Level

## 2 Press the **SET** button.

- The movie control panel will display.
- Use the or button to adjust the sound volume.



## 3 Use the or button to select (Play) and press the **SET** button.

- The movie and sound will play.
- When playback ends, the movie stops at the last frame displayed. Press the **SET** button to display the movie control panel. Press the **SET** button again to play from the beginning.



## Pausing and Resuming Play



Press the **SET** button during playback.

The movie playback pauses. Press the **SET** button again to resume.

## Operating the Movie Control Panel



**1** Select a movie and press the **SET** button (p. 94).

The movie control panel will display.



**2** Use the **◀** or **▶** button to select one of the following and press the **SET** button.



: Exit (Ends playback and returns to single image playback. Pressing the **MENU** button also returns to single image playback.)

: Play

: First Frame

: Previous Frame (Rewinds if the **SET** button is held down)

: Next Frame (Fast Forwards if the **SET** button is held down)

: Last Frame

: Edit (Switches to movie editing mode) (p. 96)



- You may experience frame dropping and audio breakup when playing back a movie on a computer with insufficient system resources.
- Movies shot with other cameras may not play back on this camera. See *List of Messages* (p. 134).



- You can adjust the playback volume of movie clips in the (Set up) menu.
- Use the television's controls to adjust the volume when playing a movie on a TV set (p. 126).

## Editing Movies



Selecting (Edit) in the movie control panel enables you to cut unwanted portions at the start or end of a movie clip.



Protected movies and movies less than 1 second in duration cannot be edited.



**1** Use the or button to select a movie and press the SET button.

Movie Editing Panel



Movie Editing Bar

**2** Switch to the movie editing mode.

- See *Operating the Movie Control Panel* (p. 95).
- The movie editing panel and the movie editing bar will display.



**3** Use the or button to select or and the or button to set the portion to which the cut is applied.

: Cut Beginning

: Cut End

: Cursor



#### 4 Use the ▲ or ▼ button to select (Play) and press the SET button.

- A preview of the temporarily edited movie clip plays.
- To stop it, press the SET button again.



#### 5 Use the ▲ or ▼ button to select (Save) and press the SET button.

Selecting  (Exit) cancels the edits and returns to the movie control panel display.



#### 6 Use the ◀ or ▶ button to select [New File] or [Overwrite] and press the SET button.

- [New File] saves the edited movie under a new file name. The pre-edit data is left unchanged.

Note, if you press the SET button while saving the movie, saving is canceled.

- [Overwrite] saves the edited movie with its original file name. The pre-edit data is lost.
- When the SD card lacks sufficient space to create a new file, only [Overwrite] can be selected.



- The minimum duration of a movie that can be edited is 1 second.
- It may take approximately 3 minutes to save an edited movie. If the battery pack runs out of charge partway through, edited movie clips cannot be saved. When editing movies, use a fully charged battery pack (p. 17).

## Rotating Images in the Display



Images can be rotated clockwise 90° or 270° in the display.



0° (Original)



90°



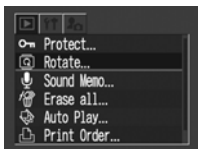

270°



**1** In the  (Play) menu, select  and press the **SET** button.

See *Selecting Menus and Settings* (p. 45).



**2** Use the  or  button to select the image to be rotated and press the **SET** button.

Cycle through the 90°/270°/0° orientations with each press of the **SET** button.



**3** Press the **MENU** button.

The display will return to the Play menu. Pressing the **MENU** button again returns to the playback screen.



- Movies cannot be rotated.
- When images are downloaded to a computer, the orientation of images rotated by the camera will depend upon the software used to download the images.



- Images can be magnified when rotated (p. 92).
- Images taken vertically with Auto Image Rotate (p. 88) set to [On] will automatically be rotated to the vertical position when viewed on the camera's LCD monitor.

## Attaching Sound Memos to Images



In playback mode (including single image playback, index playback, and magnifying playback), you can attach sound memos (up to 60 seconds) to an image. The sound data is saved in the WAVE format.

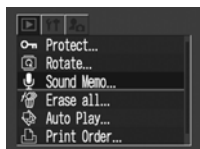

**1** In the (Play) menu, select and press the **SET** button.

See *Selecting Menus and Settings* (p. 45).



**2** Use the or button to select an image and press the **SET** button.

The sound memo control panel will display.



Sound Memo Panel



**3** Use the or button to select (Record) and press the **SET** button to record.

- The recording starts and the elapsed time is displayed.
- Press the **SET** button again to stop recording. To resume recording, press the **SET** button again.
- Up to 60 seconds of recordings may be added to any one image.
- To return to the previous screen, select (Exit) and press the **SET** button.



### Exiting Sound Memos

Press the **MENU** button until you return to the playback screen.

## Playing/Erasing Sound Memos



### 1 Display an image with a sound memo attached (p. 99) and press the SET button.

- Images with sound memos attached have the   icons displayed on them.
- The sound memo control panel will display.





Sound Memo Panel



### 2 Use the ◀ or ▶ button to select (Play) or (Erase) and press the SET button.

#### (Play)

- The sound memo will play. Playback will stop when you press the **SET** button. Press the **SET** button again to resume playback.
- Use the  or  button to adjust the sound volume.

#### (Erase)

A confirmation menu will display. Use the ◀ or ▶ button to select [Erase] and press the **SET** button.

To return the playback to the beginning, select  (Pause) while stopped and press the **SET** button.



- 
- You cannot attach sound memos to movies.
  - The “Memory card full” message will display when the SD card is full and you will be unable to record sound memos to that card.
  - If an incompatible sound memo is attached to an image, you will be unable to record or play sound memos for that image, and the “Incompatible WAVE format” message will display. You can erase incompatible sound data using the camera.
  - Sound memos for protected images cannot be erased.



---

The volume can be adjusted in the  (Set up) menu (p. 51).

## Auto Play



Use this feature to automatically playback all of the images in the SD card. The LCD monitor displays each image for approximately 3 seconds.

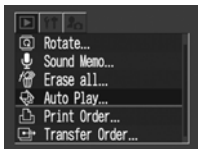

### 1 In the (Play) menu, select and press the SET button.

- See *Selecting Menus and Settings* (p. 45).
- Once you have selected it, Auto Play starts.
- As with the single image playback mode, pressing the ◀ or ▶ button during auto play will advance through the images more rapidly.

## Pausing/Resuming Auto Play



### Press the SET button.

Auto Play pauses. Press the SET button again to restart it.

## Stopping Auto Play



### Press the MENU button.

Auto Play stops.



- The display interval may vary for some images.
- Movie images play for the length of time that they were recorded.
- The power saving function is disabled during Auto Play (p. 33).



# Protecting Images



You can protect important images from accidental erasure.

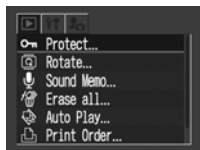

**1** In the (Play) menu, select and press the **SET** button.

See *Selecting Menus and Settings* (p. 45).



Protection Icon



**2** Use the or button to select an image to protect and press the **SET** button.

- The icon appears on protected images.
- You can make the selection of images easier by toggling between single image playback and index playback by holding down the **SET** button.



**3** Press the **MENU** button.

The Play menu displays again. Press it again to return to the playback screen.

## To Cancel Protection

After step 1, select an image to remove protection from and press the **SET** button.



Please note that formatting (initializing) an SD card erases all data, including protected images (p. 24).



## Erasing Single Images



- Please note that erased images cannot be recovered. Exercise adequate caution before erasing a file.
- Protected images cannot be erased with this function.

**1**

Use the ◀ or ▶ button to select an image for deletion and press the  button.

**2**

Use the ◀ or ▶ button to select [Erase] and press the SET button.

To exit instead of erasing, select [Cancel].



## Erasing All Images



You can erase all the images saved on the SD card.



- Please note that erased images cannot be recovered. Exercise adequate caution before erasing a file.
- Protected images cannot be erased with this function.

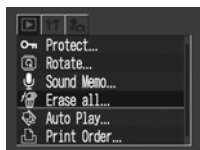

**1** In the  (Play) menu, select  and press the SET button.

See *Selecting Menus and Settings* (p. 45).



**2** Use the  or  button to select [OK] and press the SET button.

To exit instead of erasing, select [Cancel].

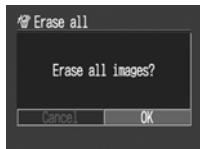

You should format the SD card when you want to erase not only image data but also all the data contained on the card (p. 24).

## About Printing



Images shot with this camera can be printed using one of the following methods.

- Connecting the camera to a direct print compatible printer<sup>\*1</sup> with a single cable and pressing the  button on the camera.
- Selecting images and specifying the number of print copies (DPOF<sup>\*2</sup> print settings) with the camera before sending the images (SD card) to a photo developing center

<sup>\*1</sup> Since this camera uses a standard protocol (PictBridge), you can use it with other PictBridge-compliant printers in addition to Canon-brand compact photo printers (SELPHY CP series), card photo printers and Bubble Jet Printers (PIXMA series/SELPHY DS series).

<sup>\*2</sup> Digital Print Order Format

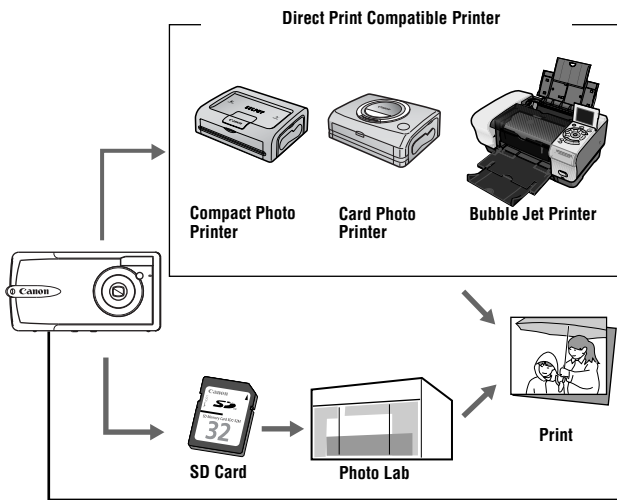

This guide explains DPOF print settings. For information on how to print images, refer to the *Direct Print User Guide* supplied with the camera. Also, refer to your printer's manual.

Please check the *System Map* to confirm the compact photo printer (SELPHY CP series), card photo printer models and Bubble Jet Printers (PIXMA series/SELPHY DS series) that can be used with this camera.

#### Direct Print Compatible Printing

- Connect the camera to the printer
- Set various print settings (except DPOF print settings)
- Print

For details, see the *Direct Print User Guide*.

#### DPOF Print Settings

- See *Selecting Images for Printing* (p. 108).  
▼
- Set the number of print copies (p. 109)  
▼
- See *Setting the Print Style* (p. 112).
  - Standard/Index/Both
  - Date: On/Off
  - File Numbers: On/Off

For details, see the *Direct Print User Guide*.

#### DPOF Transfer Order

- Select the images to download to a computer (p. 114)

## Setting the DPOF Print Settings



You can select images on an SD card for printing and specify the number of print copies in advance using the camera. This is extremely convenient for sending the images to a photo developing service that supports DPOF, or for printing on a direct print compatible printer.

See the *Direct Print User Guide* for instructions on how to print.

### Selecting Images for Printing

There are two ways to select images.

- Singly
- All images on an SD card (the number of print copies is set to one per image)

#### Single Images

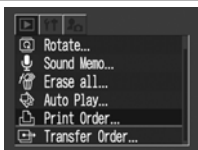

**1** In the (Play) menu, select and press the SET button.

See *Selecting Menus and Settings* (p. 45).

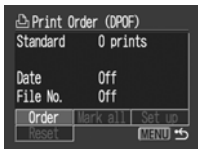

**2** Use the , , or button to select [Order] and press the SET button.

To cancel the Print Order settings, select [Reset].



Number of Print Copies



Selected for an Index Print



### 3 Select images for printing.

As shown below, selection methods differ according to the options chosen for the  (Print Type) settings (p. 112).

#### (Standard)/ (Both)

Use the ◀ or ▶ button to select an image, press the **SET** button and use the ◀ or ▶ button to select the number of print copies (up to maximum of 99).

#### (Index)

Use the ◀ or ▶ button to move to an image and the **SET** button to select or deselect it.

A checkmark displays on selected images.

You can hold down the **SET** button to switch to the index mode (3 images) and use the same procedures to select images.

### 4 Press the MENU button.

The Print Order menu will reappear.

Pressing the **MENU** button again returns to the Play menu. Press it again to go back to the playback screen.



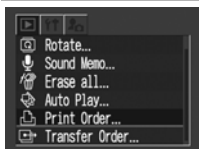

## All the Images on an SD Card

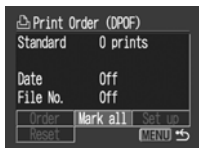

- 1** In the  (Play) menu, select  and press the SET button.

See *Selecting Menus and Settings* (p. 45).



- 2** Use the , ,  or  button to select [Mark All] and press the SET button.

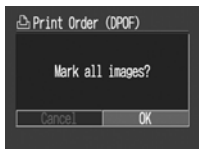

- 3** Use the  or  button to select [OK] and press the SET button.

The display returns to the Print Order (DPOF) menu.





## 4 Press the MENU button.

The display returns to the Play menu. Press the **MENU** button again to go back to the playback screen.









- The  symbol will display on images that have had print settings set by other DPOF-compliant cameras. These settings will be overwritten by those set by your camera.
- The output of some printers or photo developing services may not reflect the specified print settings.
- Print settings cannot be set for movie images.



- Images are printed in order from oldest to newest by the shooting date.
- A maximum of 998 images can be selected per SD card.
- When [Both] is selected, the number of print copies can be set, but it applies to Standard prints only. The Index setting only produces one print copy.
- Print settings can also be assigned to images with the bundled software (ZoomBrowser EX/ImageBrowser) on a computer. However, do not set the date in the DPOF print settings when printing images that have had the date embedded with the [Date Stamp] function. This may cause the date to be printed twice.

## Setting the Print Style

Set the print style after selecting the image to print. The following print settings can be selected.



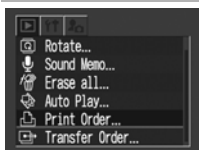

 <b>Print Type</b>	 Standard	Prints one image per page.
	 Index	Prints the selected images together at a reduced size in an index format.
	 Both	Prints the images in both the standard and index formats.
 <b>Date</b>		Adds the date to the print.
 <b>File No.</b>		Adds the file number to the print.

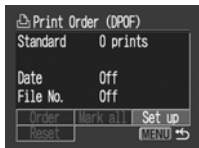

**1** In the  (Play) menu, select  and press the SET button.







See *Selecting Menus and Settings* (p. 45).



**2** Use the , ,  or  button to select [Set up] and press the SET button.

All print settings for the image are cancelled when you select [Reset].



**3** Use the  or  button to select ,  or  and the  or  button to select an option.

 **(Print Type)**

Select [Standard], [Index] or [Both].

 **(Date)**

Select [On] or [Off].

 **(File No.)**

Select [On] or [Off].



**4** Press the **MENU** button.

The Print Order menu will reappear.

Pressing the **MENU** button again returns to the Play menu. Press it again to go back to the playback screen.



- When the print type is set to [Index], only one or the other of the [Date] and [File No.] options can be set to [On] at the same time.
- If you selected [Both] or [Standard] as the Print Type, you can also set the Date and File No. settings to [On] at the same time. However, the data that is supported may vary among printers.
- Embedded dates in  (Postcard Date Imprint Mode, p. 67) print out even when [Date] is set to [Off].



The date prints in the format specified in the Date/Time menu (p. 27).

## Image Transmission Settings (DPOF Transfer Order)

You can use the camera to specify settings for images before downloading to a computer. Refer to the *Software Starter Guide* for instructions on how to transfer images to your computer.

The settings used on the camera comply with the Digital Print Order Format (DPOF) standards.



The  icon may display for an SD card that has had print settings set by a different DPOF-compliant camera. These settings will be overwritten by those set by your camera.

## Selecting Images for Transferring

There are two ways to select images.

- Singly
- All images on an SD card

### Single Images

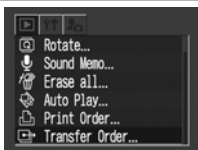

- 1** In the  (Play) menu, select  and press the SET button.

See *Selecting Menus and Settings* (p. 45).

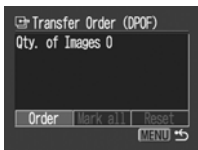

- 2** Use the  or  button to select [Order] and press the SET button.

All transfer settings for the image are cancelled when you select [Reset].



Selected for Transfer



### 3 Use the ◀ or ▶ button to move between images and the SET button to select and deselect them.

- A checkmark displays on selected images.
- You can hold down the **SET** button to switch to the index mode (3 images) and use the same procedures to select images.



### 4 Press the MENU button.

The Transfer Order menu reappears. Pressing the **MENU** button again returns to the Play menu. Press it again to go back to the playback screen.

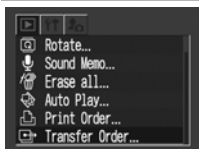

## All the Images on an SD Card

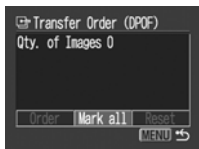

- 1** In the  (Play) menu, select  and press the SET button.

See *Selecting Menus and Settings* (p. 45).



- 2** Use the  or  button to select [Mark All] and press the SET button.

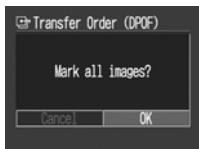

- 3** Use the  or  button to select [OK] and press the SET button.

The display returns to the Transfer Order (DPOF) menu.



#### 4 Press the **MENU** button.

The display returns to the Play menu. Press the **MENU** button again to go back to the playback screen.



- Images are transferred in order from oldest to newest by the shooting date.
- A maximum of 998 images can be selected per SD card.

## Connecting the Camera to a Computer

The following methods can be used to download images recorded by the camera to a computer. Please read *Computer System Requirements* (p. 119) in advance.

### • Downloading via a Camera to Computer Connection

Windows 98	Windows Me	Windows 2000	Windows XP	Mac OS X
---------------	---------------	-----------------	---------------	-------------

With this method, you download images using computer commands after you have installed the appropriate software.

See *Connecting the Camera to a Computer* (p. 119), and the separate *Software Starter Guide*.

Windows 98	Windows Me	Windows 2000	Windows XP
---------------	---------------	-----------------	---------------

With this method, you download images using camera button operations after you have installed the appropriate software (the computer settings only need to be adjusted for the first download).

See *Connecting the Camera to a Computer* (p. 119) and *Downloading Images by Direct Transfer* (p. 123).

Windows XP	Mac OS X
---------------	-------------

With this method, you download images using computer commands without installing any software.

See *Connecting the Camera to a Computer* (p. 119) (Software Installation Not Required) and *Connecting the Camera to the Computer to Download Images without Installing Software* (p. 125).

### • Downloading Directly from an SD Card

See *Downloading Directly from an SD Card* (p. 125).



# Connecting the Camera to a Computer

## Computer System Requirements

Please install and use the software on a computer which meets the requirements below.

### Windows

<b>OS</b>	Windows 98 (Second Edition (SE) Only) Windows Me Windows 2000 (Service Pack 4 Only) Windows XP (Including Service Pack 1)
<b>Computer Model</b>	The above OS should be pre-installed on computers with built-in USB ports.
<b>CPU</b>	Pentium 500 MHz or higher processor is required
<b>RAM</b>	Windows 98 SE/Windows Me: 128 MB or more Windows 2000/Windows XP: 256 MB or more
<b>Interface</b>	USB
<b>Free Hard Disk Space</b>	<ul style="list-style-type: none"><li>• Canon Utilities<ul style="list-style-type: none"><li>- ZoomBrowser EX: 250 MB or more (Including the PhotoRecord printing program)</li><li>- PhotoStitch: 40 MB or more</li></ul></li><li>• Canon Camera TWAIN Driver: 25 MB or more</li><li>• Canon Camera WIA Driver: 25 MB or more</li></ul>
<b>Display</b>	1,024 x 768 pixels / High Color (16 bit) or better is required

### Macintosh

<b>OS</b>	Mac OS X (v10.1.5 – v10.3)
<b>Computer Model</b>	The above OS should be pre-installed on computers with built-in USB ports.
<b>CPU</b>	PowerPC G3/G4/G5
<b>RAM</b>	256 MB or more
<b>Interface</b>	USB
<b>Free Hard Disk Space</b>	<ul style="list-style-type: none"><li>• Canon Utilities<ul style="list-style-type: none"><li>- ImageBrowser: 200 MB or more</li><li>- PhotoStitch: 40 MB or more</li></ul></li></ul>
<b>Display</b>	1,024 x 768pixels / 32,000 colors or better is required

## IMPORTANT

**You must install the software and driver bundled on the supplied Canon Digital Camera Solution Disk onto your computer before connecting the camera to a computer.**



The camera will not operate correctly if you connect it to your computer before installing the driver and software. If this happens, please refer to the Troubleshooting section of the *Software Starter Guide*.



- You do not need to turn off the camera or computer power when making a USB connection.
- Please refer to your computer's manual for information regarding the location of the USB port.
- You are recommended to use a fully charged battery pack to power the camera when connecting to a computer (p. 17).
- All procedures performed with a connection to a USB 2.0 compliant board are not guaranteed.

## 1 Install the driver and the software applications bundled on the Canon Digital Camera Solution Disk (first time only).

- Please see the *Software Starter Guide* for the installation procedures.
- With a Macintosh, it is next necessary to set the ImageBrowser auto start settings. Please see the *Software Starter Guide* for details.

## 2 Use the supplied interface cable to connect the computer's USB port to the camera's DIGITAL terminal.

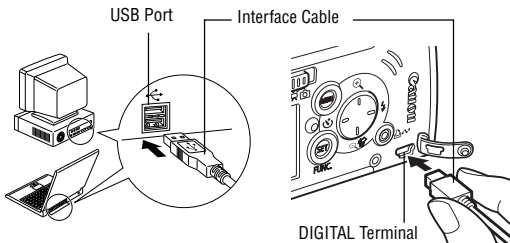

- To connect the interface cable to the camera's DIGITAL terminal, lift the terminal cover with a fingernail under its upper edge and insert the connector until it clicks into place.
- Always grasp the connector's sides to remove the interface cable from the camera's DIGITAL terminal.

**3** Set the mode switch to  (Playback).

**4** Press the ON/OFF button until the power lamp lights green.

• **Windows:**

Proceed to step 5 below.

• **Macintosh:**

Refer to the *Software Starter Guide* and download images.

**5** Select [Canon CameraWindow] in the event dialog that appears on the computer and click [OK] (first time only).

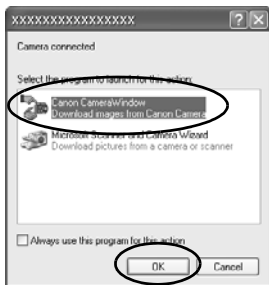

If the event dialog fails to appear, click the [Start] menu, and select [Programs] or [All Programs], followed by [Canon Utilities], [Camera Window] and [Camera Window].





The following window will display.



- **Using the software and computer to download images:**  
See the *Software Starter Guide*.
- **Using the Camera to Download Images (Direct Transfer Function)**  
See *Downloading Images by Direct Transfer* (p. 123).

## Downloading Images by Direct Transfer

Use this method to download images using camera operations. Install the supplied software and adjust the computer settings before using this method for the first time (p. 120).

	<b>All Images</b>	Transfers and saves all images to the computer.
	<b>New Images</b>	Transfers and saves to the computer only the images that have not been previously transferred.
	<b>DPOF Trans. Images</b>	Transfers and saves to the computer only the images with DPOF Transfer Order settings (p. 114).
	<b>Select &amp; Transfer</b>	Transfers and saves single images to the computer as you view and select them.
	<b>Wallpaper</b>	Transfers and saves single images to the computer as you view and select them. The transferred images display on the computer desktop.

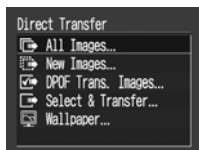

### 1 Confirm that the Direct Transfer menu is displayed on the camera's LCD monitor.

- The  button will light blue.
- Press the **MENU** button if the Direct Transfer menu fails to appear.

## All Images/New Images/DPOF Trans. Images





### 2 Use the or button to select , or , and press the (Print/Share) button.

- To cancel the transfer, press the **SET** button.
- The images will download. The  button will blink blue while downloading is in progress. The display will return to the Direct Transfer menu when the download is complete.

## Select & Transfer/Wallpaper



**2** Use the ▲ or ▼ button to select  or , and press the  button (or SET button).



**3** Use the ◀ or ▶ button to select images to download and press the  button (or SET button).

The images will download. The  button will blink blue while downloading is in progress.



**4** Press the MENU button.  
The Direct Transfer menu will reappear.



Only JPEG format images can be downloaded as wallpaper for the computer. They are automatically converted to the BMP format after downloading.



The option selected with the  button is retained even when the camera's power is turned off. The previous setting will be in effect the next time the Direct Transfer menu is displayed. The image selection screen will appear directly when the [Select & Transfer] or the [Wallpaper] option was last selected.

## Connecting the Camera to the Computer to Download Images without Installing Software

If you are using Windows XP or Mac OS X (v10.1.5 – v10.3), you can use the software distributed with these operating systems to download images without installing the software bundled on the Canon Digital Camera Solution Disk. This is useful for downloading images to a computer in which the software is not installed.

However, please note that there are certain limitations to downloading with this method. For more details, please refer to the supplied leaflet entitled for *For Windows® XP and Mac OS X Users*.

- 1 Use the supplied interface cable to connect the computer's USB port to the camera's DIGITAL terminal.**

See steps 2-4 and onward starting on p.120.

- 2 Follow the onscreen instructions to proceed with downloading.**

## Downloading Directly from an SD Card

- 1 Eject the SD card from the camera and insert it into an SD card reader connected to the computer.**

Refer to your card adapter's or card reader's manual for information regarding the connection between the computer and card adapter or card reader.

- 2 Double-click the icon of the drive containing the SD card.**

Depending on the operating system, the drive containing the SD card may display automatically.

- 3 Copy the SD card's images to the desired folder on the hard disk.**

The images are contained in the [xxxCANON] folder, which is a subfolder of the [DCIM] folder on the SD card. The xxx represents a number from 100 to 998 (p. 90).

### Viewing Images on a TV set

You can use a video-compatible television as a monitor to shoot or play back images when it is connected to the camera with the supplied AV Cable AVC-DC300.



#### 1 Turn off the Camera and the TV. (p. 32)

Also turn the television off.

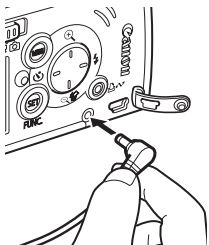

#### 2 Connect the AV cable to the camera's A/V OUT terminal.

Slip your fingernail under the left edge of the terminal cover to open it and insert the cable securely.

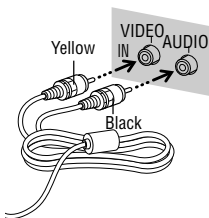



#### 3 Plug the other ends of the AV cable to the VIDEO IN and AUDIO IN jacks on the TV.

#### 4 Turn on the TV and switch it to Video mode.

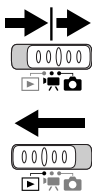



**5** Slide the mode switch to  (Shooting),  (Movie) or  (Playback).



**6** Press the ON/OFF button until the indicator blinks green.

The image will appear on the TV. Shoot or play back images as usual.



- A TV set cannot be used in Stitch Assist mode.
- No image will appear on the LCD monitor when the camera is connected to a TV.
- If the TV is a stereo model, you can plug the audio plug into either the left or right Audio In jack. Please refer to the TV's manual for details.



The video output signal can be switched (NTSC or PAL) to accommodate different regional standards (p. 52). The default setting varies between regions.

- NTSC: Japan, U.S.A., Canada, Taiwan and others
- PAL: Europe, Asia (excluding Taiwan), Oceania and others

If the video system is set incorrectly, the camera output may not display properly.

## Customizing the Camera (My Camera Settings)

My Camera allows you to customize the start-up image and start-up, operation, self-timer and shutter sounds. Each menu item has three choices.

Example: Start-up Image

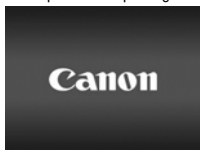

1

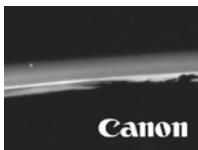

2



3

The **2** option features science fiction related images and sounds. The **3** option features animals.

## Changing My Camera Settings



**1** Select the **My Camera** menu.

See *Selecting Menus and Settings* (p. 45).



**2** Use the **▲** or **▼** button to select an item.



**3** Use the **◀** or **▶** button to select an option.





## 4 Press the MENU button.

- The menu will close.
- In Shooting mode, the menu can be closed by pressing the shutter button halfway.



- If you select  (Theme) in Step 2, you can select a consistent theme for each of the My Camera settings.
- The beep will not sound but the start-up image will display if the [Mute] option in the  (Set up) menu is set to [On] even if a setting has been selected in the My Camera menu.

## Registering My Camera Settings

Images recorded onto the SD card and newly recorded sounds can be added as My Camera settings to the **[2]** and **[3]** menu items. You can also use the supplied software to upload your computer's images and sounds to the camera.

The following menus can be saved to the camera.

- Start-up Image
- Shutter Sound
- Selftimer Sound
- Operation Sound
- Start-up Sound



A computer is required to restore the My Camera Settings to the defaults. Use the supplied software (ZoomBrowser EX/ImageBrowser) to add the default settings to the camera.

## Registering SD Card Images and Sounds



**1** Slide the mode switch to  (Playback).



**2** Select the  (My Camera) menu.  
See *Selecting Menus and Settings* (p. 45).



**3** Use the  or  button to select an item.



**4** Use the  or  button to select **[2]** or **[3]**.

The **SET**  icon will display.





## 5 Press the SET button.



## 6 Select an image or record a sound.



### Start-up Image

Use the ◀ or ▶ button to select the image you wish to register and press the SET button.



### Start-up, Operation, Self-timer and Shutter Sounds

- Use the ◀ or ▶ button to select (Record) and press the SET button. Recording will start and automatically stop when the time is exceeded.
- After recording, use the ◀ or ▶ button to select (Register Sound) and press the SET button.
- Select (End) to return to the My Camera menu without registering.
- Select (Play) to play the recorded sound.

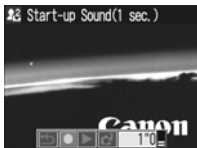

## 7 Use the ◀ or ▶ button to select [OK] and press the SET button.

To cancel the change, select [Cancel].



- The following cannot be registered as My Camera Settings.
  - Movies
  - Sounds recorded with the sound memo function (p. 99)
- The prior setting is erased when a new My Camera setting is added.

## File Format of My Camera Settings





My Camera settings should conform to the file formats below. However, SD card images shot with this camera can be registered as My Camera settings regardless of the below formats. (Excluding sounds recorded as a movie or with the sound memo function (p. 99).)

### Start-up Image

- Recording Format: JPEG (Baseline JPEG)
- Sampling Rate: 4:2:0 or 4:2:2
- Dimensions: 320 x 240 pixels
- File Size: 20 KB or less

### Start-up, Operation, Self-timer and Shutter Sounds

- Recording format: WAVE (monaural)
- Quantization Bits: 8 bit
- Sampling Frequency: 11.025 kHz or 8.000 kHz
- Recorded Length

	11.025 kHz	8.000 kHz
 Start-up Sound	1.0 sec. or less	1.3 sec. or less
 Operation Sound	0.3 sec. or less	0.4 sec. or less
 Selftimer Sound	2.0 sec. or less	2.0 sec. or less
 Shutter Sound	0.3 sec. or less	0.4 sec. or less

\* Any file formats other than those described above cannot be used with this camera.

An example of this function is to record “Say Cheese” as a self-timer sound so that the camera will replay this sound 2 seconds before the photo is taken. You could also record cheerful music to bring out the natural smiles of your subjects, or so they can strike a pose fitting the music. In these ways you can customize your camera by creating and adding new My Camera settings.



See the supplied *Software Starter Guide* for more information on creating and adding to the My Camera files.







## List of Messages

The following messages may appear on the LCD monitor during shooting or playback. Please refer to the *Direct Print User Guide* for the messages that display during a printer connection.

<b>Busy...</b>	Image is being recorded to, or read from, SD card.
<b>No memory card</b>	You attempted to shoot or play back images without an SD card installed.
<b>Card locked!</b>	The SD card is write-protected.
<b>Cannot record!</b>	You attempted to shoot an image without an SD card installed, or attempted to attach a sound memo to a movie.
<b>Memory card error!</b>	SD card has experienced an anomaly.
<b>Memory card full</b>	SD card is full and no more images can be recorded. Also, no further image settings (e.g. print settings) or sound memos can be recorded.
<b>Naming error!</b>	The file could not be created because there is a file with the same name as the directory that the camera is attempting to create, or the highest possible file number has already been reached. In the  Rec. Menu, set the File Reset option to On. Save all the images you wish to retain onto a computer, then reformat the SD card. Please note that formatting will erase all the existing images and other data.
<b>Change the battery pack</b>	Battery charge is insufficient to operate the camera. Replace it at once with a charged one or recharge the battery pack.
<b>No image</b>	No images recorded on SD card.
<b>Image too large</b>	You attempted to play back an image larger than 4064 x 3048 pixels or with a large file size.
<b>Incompatible JPEG format.</b>	You attempted to play back an incompatible JPEG file.
<b>Corrupted Data</b>	You attempted to play back an image with corrupted data.



<b>RAW</b>	You attempted to play back an image recorded in the RAW format.
<b>Unidentified Image</b>	You attempted to play back an image that was recorded in a special format (proprietary format used by the camera of another manufacturer, etc.) or a movie clip recorded by another camera.
<b>Cannot magnify!</b>	You attempted to magnify an image recorded in a different camera or format, an image edited with a computer, or a movie.
<b>Cannot rotate</b>	You attempted to rotate an image recorded in a different camera or format, an image edited with a computer, or a movie.
<b>Incompatible WAVE format</b>	A sound memo cannot be added to this image since the format of the existing sound memo is incorrect.
<b>Cannot register this image!</b>	You attempted to add a start-up image or a movie that was created with another camera.
<b>Protected!</b>	You attempted to erase a protected image.
<b>Too many marks</b>	Too many images have been marked with print settings or transfer settings. Cannot process any more.
<b>Unselectable image</b>	You attempted to set the print settings for a non-JPEG file.
<b>Cannot complete!</b>	Couldn't save the print or transfer settings.
<b>Exx</b>	(xx: number) Camera malfunction. Turn the power off and then back on, then shoot or play back. A problem exists if the error code reappears. Note the number and contact your Canon Customer Support Help Desk. If an error code displays directly after taking a picture, the shot may not have been recorded. Check image in playback mode.

Problem	Cause	Solution
Camera will not operate	Power is not turned on	<ul style="list-style-type: none"> <li>Press the <b>ON/OFF</b> button for a moment.</li> </ul>
	SD card slot/battery cover is open	<ul style="list-style-type: none"> <li>Confirm that the SD card slot/battery cover is securely closed.</li> </ul>
	Insufficient battery voltage	<ul style="list-style-type: none"> <li>Insert a fully charged battery into the camera.</li> </ul>
	Poor contact between camera and battery terminals	<ul style="list-style-type: none"> <li>Wipe the terminals with a clean dry cloth.</li> </ul>
Camera will not record	Mode switch is set to  (Playback)	<ul style="list-style-type: none"> <li>Set the mode switch to  or .</li> </ul>
	Flash is charging (Blinking  in the LCD monitor)	<ul style="list-style-type: none"> <li>The indicator will light orange when it is charged. You can then press the shutter button.</li> </ul>
	SD card is full	<ul style="list-style-type: none"> <li>Insert a new SD card.</li> <li>If required, download the images to a computer and erase them from the SD card to make space.</li> </ul>
	SD card is not formatted correctly	<ul style="list-style-type: none"> <li>Format SD card.                             <ul style="list-style-type: none"> <li>➔ See <i>Formatting SD Cards</i> (p. 24).</li> </ul> </li> <li>If reformatting does not work, the SD card logic circuits may be damaged. Consult the nearest Canon Customer Support Help Desk.</li> </ul>
Cannot play back	SD card is write-protected.	<ul style="list-style-type: none"> <li>Slide the write protect tab of the SD card upward (p. 22).</li> </ul>
	You attempted to play back images shot with another camera or images edited with a computer	<ul style="list-style-type: none"> <li>Computer images that cannot be played back will play back if they are added to the camera using the bundled software program ZoomBrowser EX or ImageBrowser. See <i>ZoomBrowser EX/ImageBrowser Software User Guide</i> (PDF).</li> </ul>

<b>Problem</b>	<b>Cause</b>	<b>Solution</b>
Cannot play back	File name was changed with a computer or file location was changed	<ul style="list-style-type: none"> <li>• Set the file name or location on the file format/structure of the camera.</li> <li>➡ See <i>About File Numbers and Folder Numbers</i> (p. 90).</li> </ul>
Lens will not retract	SD card slot/battery cover was opened with power on	<ul style="list-style-type: none"> <li>• First close the SD card slot/battery cover and then turn the power off.</li> </ul>
	SD card slot/battery cover was opened while recording to the SD card (warning signal sounds)	<ul style="list-style-type: none"> <li>• First close the SD card slot/battery cover and then turn the power off.</li> </ul>
Battery pack consumed quickly	Battery life exceeded if battery pack loses its charge quickly at normal temperature (23 °C/73 °F)	<ul style="list-style-type: none"> <li>• Replace the battery pack with a new one.</li> </ul>
Battery pack will not charge	Battery pack life exceeded	<ul style="list-style-type: none"> <li>• Replace the battery pack with a new one.</li> </ul>
	Poor contact between battery pack and battery charger	<ul style="list-style-type: none"> <li>• Insert battery pack securely into battery charger.</li> <li>• Ensure that battery charger plug is securely plugged into the power outlet.</li> </ul>
Sounds come from the camera interior	The camera's horizontal/vertical orientation was changed	<ul style="list-style-type: none"> <li>• The camera's orientation mechanism is operating. There is no malfunction.</li> </ul>
Image is blurred or out of focus	Camera moved	<ul style="list-style-type: none"> <li>• Be careful not to move the camera while pressing the shutter button.</li> </ul>
	Autofocus function hampered by obstruction to AF-assist Beam	<ul style="list-style-type: none"> <li>• Be careful not to block the AF-assist Beam with fingers or other items.</li> </ul>
	AF-assist Beam is set to [Off]	<ul style="list-style-type: none"> <li>• Set the AF-assist Beam to [On] (p. 49).</li> </ul>

<b>Problem</b>	<b>Cause</b>	<b>Solution</b>
Image is blurred or out of focus	Subject is out of focal range	<ul style="list-style-type: none"> <li>• Ensure there is at least 10 cm (3.9 in.) between the camera lens and subject.</li> <li>• Use the Macro mode to shoot close-ups between 3 and 10 cm (1.2 to 3.9 in.) from the lens.</li> </ul>
	The subject is hard to focus on	<ul style="list-style-type: none"> <li>• Use the focus lock to shoot. ➔ See <i>Shooting Hard-to-Focus Subjects (Focus Lock)</i> (p. 76).</li> </ul>
Subject in recorded image is too dark	Insufficient light for shooting	<ul style="list-style-type: none"> <li>• Set the flash to on.</li> </ul>
	Subject is dark in contrast to the background	<ul style="list-style-type: none"> <li>• Set the exposure compensation to a positive (+) setting or use the spot metering function.</li> </ul>
	Subject is too far away for flash to reach	<ul style="list-style-type: none"> <li>• Shoot within 2.0 m (6.6 ft.) of the subject when using the flash.</li> <li>• Raise the ISO sensitivity and then shoot. See <i>Adjusting the ISO Speed</i> (p. 87).</li> </ul>
Subject in recorded image is too bright	Subject is too close, making the flash too strong	<ul style="list-style-type: none"> <li>• When using the flash, stay at least 30 cm (1.0 ft.) from the subject.</li> </ul>
	Subject is bright in contrast to the background	<ul style="list-style-type: none"> <li>• Set the exposure compensation to a negative (-) setting or use the spot metering function.</li> </ul>
	Light is shining directly on the subject or reflected off the subject into the camera	<ul style="list-style-type: none"> <li>• Change the shooting angle.</li> </ul>
	Flash is set to on	<ul style="list-style-type: none"> <li>• Set the flash to off.</li> </ul>
A bar of light (red, purple) appears on the LCD monitor	Subject is too bright	<ul style="list-style-type: none"> <li>• This is a normal occurrence in devices containing CCDs and does not constitute a malfunction. (This bar of light will not be recorded when shooting still photos, but it will be recorded when shooting movies.)</li> </ul>

<b>Problem</b>	<b>Cause</b>	<b>Solution</b>
White dots appear on the image	Light from the flash has reflected off dust particles or insects in the air.	<ul style="list-style-type: none"> <li>• This is a phenomenon that occurs with digital cameras and does not constitute a malfunction.</li> </ul>
Flash does not fire	Flash is set to off	<ul style="list-style-type: none"> <li>• Set the flash to on.</li> </ul>
Image not showing on TV monitor	Incorrect video system setting	<ul style="list-style-type: none"> <li>• Set the video system to the appropriate setting, NTSC or PAL, for your TV (p. 52).</li> </ul>
	Shooting in Stitch Assist mode	<ul style="list-style-type: none"> <li>• The output will not appear on a TV in Stitch Assist mode. Cancel the Stitch Assist mode.</li> </ul>
Reading images from SD card is slow	SD card was formatted in another device	<ul style="list-style-type: none"> <li>• Use an SD card formatted in your camera.</li> <li>➡ See <i>Formatting SD Cards</i> (p. 24).</li> </ul>
Recording images to SD card takes a long time		

## Camera Care and Maintenance

Use the following procedures to clean the camera body, lens and LCD monitor.



---

Never use thinners, benzene, synthetic cleansers or water to clean the camera. These substances may distort or damage the equipment.

### Camera Body

Gently wipe dirt off the camera body with a soft cloth or eyeglass lens wiper.

### Lens

First use a lens blower brush to remove dust and dirt, then remove any remaining dirt by wiping the lens lightly with a soft cloth.



---

Never use synthetic cleansers on the camera body or lens. If dirt remains, contact the closest Canon Customer Support Help Desk as listed on the separate *Canon Customer Support* leaflet.

### LCD Monitor

Use a lens blower brush to remove dust and dirt. If necessary, gently wipe with a soft cloth or an eyeglass lens wiper to remove stubborn dirt.



---

Never rub or press strongly on the LCD monitor. These actions may damage it or lead to other problems.

## Specifications

All data is based on Canon's standard testing methods. Subject to change without notice.

### PowerShot SD20 DIGITAL ELPH/DIGITAL IXUS i<sup>5</sup>

<b>Camera Effective Pixels</b>	Approx. 5.0 million
<b>Image Sensor</b>	1/2.5-inch CCD (Total number of pixels: Approx. 5.4 million)
<b>Lens</b>	6.4 mm (35 mm film equivalent: 39 mm) f/2.8
<b>Digital Zoom</b>	Approx. 6.5x
<b>LCD Monitor</b>	1.5-inch, low-temperature polycrystalline silicon TFT color LCD, approx. 78,000 pixels (Picture coverage 100%)
<b>AF System</b>	TTL autofocus Focusing frame: 9-point AiAF/1-point AF (center)
<b>Shooting Distance (From the front of the lens)</b>	Normal AF: 10 cm (3.9 in.) – infinity Macro AF: 3 – 10 cm (1.2 – 3.9 in.)
<b>Shutter</b>	Mechanical shutter + electronic shutter
<b>Shutter Speeds</b>	15* – 1/1500 sec. * Depending on shooting mode Slow shutter speeds of 1.3 sec. or slower operate with noise reduction.
<b>Light Metering System</b>	Evaluative, Center-weighted average or Spot (Center)
<b>Exposure Control System</b>	Program AE
<b>Exposure Compensation</b>	± 2.0 stops in 1/3-stop increments
<b>Sensitivity</b>	Auto, ISO 50/100/200/400 equivalent
<b>White Balance</b>	TTL auto, pre-set (available settings: Daylight, Cloudy, Tungsten, Fluorescent or Fluorescent H) or custom
<b>Built-in Flash</b>	Auto*, on*, off, slow-synchro * Red-eye reduction is available.
<b>Flash Range</b>	30 cm – 2.0 m (1.0 – 6.6 ft.) (When sensitivity is set to AUTO.)

<b>Shooting Modes</b>	Auto, Manual*, Macro, Portrait, Landscape, Night snapshot, Indoor, Underwater, Stitch assist**, Movie * Long shutter mode available ** Selectable from the Rec. menu
<b>Continuous Shooting</b>	Approx. 0.9 shots/sec. (Large/Fine mode)
<b>Self-timer</b>	Activates shutter after an approx. 10-sec./approx. 2-sec. delay
<b>Recording Media</b>	SD memory card
<b>File Format</b>	Design rule for camera file system and DPOF compliant
<b>Image Recording Format</b>	Still images: JPEG (Exif 2.2) <sup>*1</sup> Movies: AVI (Image data: Motion JPEG; Audio data: WAVE (monaural))
<b>Compression</b>	Superfine, Fine, Normal
<b>Number of Recording Pixels</b>	Still images: Large: 2592 x 1944 pixels Medium 1: 2048 x 1536 pixels Medium 2: 1600 x 1200 pixels Small: 640 x 480 pixels Movies: 640 x 480 pixels (30 sec.) 10 frames/second 320 x 240 pixels (3 min.) 15 frames/second 160 x 120 pixels (3 min.) 15 frames/second The data in parentheses refer to the maximum movie length per shooting.
<b>Playback Modes</b>	Single (histogram displayable), Index (9 thumbnail images), Magnified (approx. 10x (max.) in LCD monitor, advance or reverse through magnified images possible), Sound memos (up to 60 sec.) or Auto play
<b>Direct Print</b>	<i>Canon Direct Print</i> and <i>Bubble Jet Direct</i> compatible, and <i>PictBridge</i> compliant
<b>Display Languages</b>	21 languages available for menus and messages (English, German, French, Dutch, Danish, Finnish, Italian, Norwegian, Swedish, Spanish, Simplified Chinese, Russian, Portuguese, Greek, Polish, Czech, Hungarian, Turkish, Traditional Chinese, Korean and Japanese)



<b>My Camera Settings</b>	The start-up image, start-up sound, operation sound, self-timer sound and shutter sound can be customized using the following methods: <ol style="list-style-type: none"> <li>1. Using the images and sounds recorded on a camera.</li> <li>2. Using the downloaded data from your computer using the supplied software.</li> </ol>
<b>Interface</b>	USB (mini-B, PTP [Picture Transfer Protocol]), Audio/Video output (NTSC or PAL selectable, monaural audio)
<b>Power Source</b>	Rechargeable lithium-ion battery (type: NB-3L) (included in the camera kit/sold separately)
<b>Operating Temperature</b>	0 – 40 °C (32 – 104 °F)
<b>Operating Humidity</b>	10 – 90%
<b>Dimensions</b>	90.3 x 47.0 x 18.5 mm (3.56 x 1.85 x 0.73 in.) (excluding protrusions)
<b>Weight</b>	Approx. 100 g (3.53 oz.) (camera body only)

\*1 This digital camera supports Exif 2.2 (also called “Exif Print”). Exif Print is a standard for enhancing the communication between digital cameras and printers. By connecting to an Exif Print-compliant printer, the camera’s image data at the time of shooting is used and optimized, yielding extremely high quality prints.

## Battery Performance

	Number of Images Shot	Playback Time
	LCD Monitor ON (Based on the CIPA standard)	
Battery Pack NB-3L (Fully Charged)	Approx. 120 images	Approx. 140 minutes

- The actual figures will vary according to the shooting conditions and settings.
- Movie data is excluded.
- At low temperatures, the battery pack performance may diminish and the low battery icon appear very rapidly. In these circumstances, the performance can be improved by warming the battery pack in a pocket before use.

### Test Conditions

Shooting: Normal temperature ( $23\text{ }^{\circ}\text{C} \pm 2\text{ }^{\circ}\text{C}/73\text{ }^{\circ}\text{F} \pm 3.6\text{ }^{\circ}\text{F}$ ), normal relative humidity ( $50\% \pm 20\%$ ), alternating wide angle end and telephoto end shots at 30 second intervals with the flash fired once every two shots and the camera power turned off after every tenth shot.

Power is left off for a sufficient amount of time\*, then the power is turned back on and the testing procedure is repeated.

- The included memory card is used.

\*Until the battery returns to normal temperature















Playback: Normal temperature ( $23\text{ }^{\circ}\text{C} \pm 2\text{ }^{\circ}\text{C}/73\text{ }^{\circ}\text{F} \pm 3.6\text{ }^{\circ}\text{F}$ ), normal relative humidity ( $50\% \pm 20\%$ ), continuous playback at 3 seconds per image.











See *Battery Pack Handling Precautions* (p. 19).







## SD Cards and Estimated Capacities

: With card included with the camera

		SDC-32M	SDC-128M	SDC-512MSH
<b>L</b> (2592 x 1944 pixels)		11	48	195
		20	85	347
		40	170	687
<b>M1</b> (2048 x 1536 pixels)		17	74	302
		32	134	542
		63	264	1066
<b>M2</b> (1600 x 1200 pixels)		28	119	483
		51	212	859
		97	403	1628
<b>S</b> (640 x 480 pixels)		108	451	1819
		168	697	2812
		265	1096	4420
Movie	 (640 x 480 pixels)	42 seconds	178 seconds	719 seconds
	 (320 x 240 pixels)	84 seconds	348 seconds	1406 seconds
	 (160 x 120 pixels)	206 seconds	852 seconds	3438 seconds

- The maximum movie clip length is approximately : 30 sec., : 3 min. or : 3 min. The times shown are the maximum continuous recording times.
- **L** (Large), **M1** (Medium 1), **M2** (Medium 2), **S** (Small), ,  and  indicate the recording resolution.
- ,  and  indicate the compression setting.

## Image File Sizes (Estimated)

Resolution		Compression		
				
<b>L</b>	(2592 x 1944)	2503 KB	1395 KB	695 KB
<b>M1</b>	(2048 x 1536)	1602 KB	893 KB	445 KB
<b>M2</b>	(1600 x 1200)	1002 KB	558 KB	278 KB
<b>S</b>	(640 x 480)	249 KB	150 KB	84 KB
Movies	 (640 x 480)	660 KB/sec.		
	 (320 x 240)	330 KB/sec.		
	 (160 x 120)	120 KB/sec.		

## SD Memory Card

Interface	Compatible with SD memory card standards
Dimensions	32.0 x 24.0 x 2.1 mm (1.3 x 0.9 x 0.1 in.)
Weight	Approx. 2 g (0.1 oz.)

## Battery Pack NB-3L

Type	Rechargeable Lithium Ion Cell
Nominal Voltage	3.7 V
Typical Capacity	790 mAh
Cycle Life	Approx. 300 times
Operating Temperatures	0 – 40 °C (32 – 104 °F)
Dimensions	32.0 x 44.8 x 9.0 mm (1.3 x 1.8 x 0.4 in.)
Weight	Approx. 22 g (0.8 oz.)

## Battery Charger CB-2LU/CB-2LUE

Rated Input	100 – 240 V AC (50/60 Hz) 0.085 A (100 V) – 0.05 A (240 V)
Rated Output	4.2 V DC/0.7 A
Charging Time	Approx. 95 minutes
Operating Temperatures	0 to 40 °C (32 to 104 °F)
Dimensions	52.0 x 71.0 x 25.8 mm (2.0 x 2.8 x 1.0 in.)
Weight	Approx. 56 g (2.0 oz.) (CB-2LU) Approx. 58 g (2.0 oz.) (CB-2LUE)

## Photo Tips and Information

### Tip for Using the Self-timer (p.68)

Normally the camera shakes a little when you press the shutter button. Setting the self-timer to  delays the shutter release for 2 seconds and allows the camera to stop shaking, thus preventing a blurred image. Even better results can be obtained by placing the camera on a stable surface or by using a tripod to shoot.

### How to Adjust the Exposure (p.79)

This camera automatically adjusts the exposure to shoot images with the optimal brightness. However, recorded images may sometimes be brighter or darker than the actual image depending on the shooting conditions. If this happens, adjust the exposure compensation manually.



#### Underexposure

The whole recorded image is dark, which makes white elements of the image appear gray. Shooting bright subjects or in backlit conditions may cause the image to be underexposed. Adjust the exposure compensation towards the + end.



#### Optimal Exposure



#### Overexposure

The whole recorded image is bright, which makes black elements of the image appear gray. Shooting dark subjects or in dark places may cause the image to be overexposed. Adjust the exposure compensation towards the - end.

## ISO Speed (p.87)

The ISO speed is the numeric representation of the camera's sensitivity to light. The higher the ISO speed, the higher the sensitivity. A high ISO speed allows you to shoot images in dark indoor or outdoor conditions without a flash and also helps prevent blurred images due to camera shake. This is convenient when shooting images in places where flash photography is prohibited. The ISO speed setting makes full use of the available light, resulting in images that convey the feel of the place they were shot.

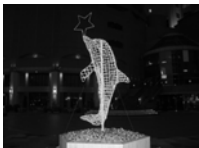

ISO 50 equivalent



ISO 400 equivalent





**A**

AF Frame .....	43
AF-assist Beam.....	44
AiAF.....	44
Auto Play.....	102
Auto Rotate Function.....	88
Autofocus.....	44
AV Cable AVC-DC300 .....	126

**B**

## Battery

Charging.....	17
Handling .....	19
Installing.....	20
Performance.....	144

**C**

Clock Display.....	29
Compression.....	58
Computer System Requirements .....	119
Connecting the Camera to a Com- puter.....	118
Continuous Shooting.....	65
Custom White Balance .....	84

**D**

Date/Time.....	27
DIGITAL Terminal.....	120
Digital Zoom.....	42
Direct Interface Cable .....	14
Direct Transfer .....	123
DPOF Print Order.....	108
Print Style.....	112
Selecting Images .....	108
DPOF Transfer Order .....	114

**E**

Erasing .....	104
All Images.....	105
Single Images.....	104
Exposure .....	79

**F**

File Number.....	89
Flash.....	60
Focus Lock.....	76
FUNC. Menu .....	46

**H**

Histogram .....	41
-----------------	----

**I**

Image File Sizes .....	146
Index Playback .....	93
Indicator.....	16, 32
Interface Cable .....	120
ISO Speed .....	87

**L**

Language .....	30
LCD Monitor.....	35
Information Displayed .....	37
Using the LCD Monitor .....	35

**M**

Magnifying .....	92
Menu	
Menu Settings and Factory Defaults .....	49
My Camera Menu .....	53
Play Menu.....	50
Rec. Menu .....	49
Set up Menu .....	50
Messages.....	134
Metering Modes .....	78

Mode switch .....	34
Movie .....	70
Editing .....	96
Playback .....	94
Shooting .....	70
Mute Mode .....	50
My Camera Menu	
Changing .....	128
Registering .....	130
My Camera Settings .....	128
File Format .....	132

## O

ON/OFF Button .....	32
---------------------	----

## P

Photo Effect .....	86
Play Menu .....	50
Playback Mode .....	34
Postcard Date Imprint Mode .....	66
Power-saving .....	33
Print/Share Button .....	15
Protect .....	103

## Q

Quick Shot .....	44
------------------	----

## R

Rec. Menu .....	49
Red-Eye Reduction Function .....	61
Resolution .....	58
Review Duration .....	56
Rotate .....	98

## S

SD Card .....	22
Capacities .....	145
Formatting .....	24
Handling .....	26
Installing .....	22
Self-Timer .....	68
Set up Menu .....	50
Shooting Mode	
Auto .....	55
Functions Available in Each Shooting Mode .....	160
Indoor .....	62
Landscape .....	62
Macro .....	64
Manual .....	62
Night Snapshot .....	62
Portrait .....	62
Stitch Assist .....	72
Underwater .....	62
Shutter Button .....	43
Pressing Fully .....	43
Pressing Halfway .....	43
Quick Shot .....	44
Shutter Speed .....	80
Single Image Playback .....	91
Sound Memo .....	99
Spot AE Point Frame .....	38, 78

## U

USB port .....	120
----------------	-----

## V

Video Output System .....	127
---------------------------	-----

## W

White Balance .....	82
Wrist Strap .....	13

# MEMO

# MEMO

# MEMO

# MEMO

# MEMO

## **Disclaimer**

- While every effort has been made to ensure that the information contained in this guide is accurate and complete, no liability can be accepted for any errors or omissions.
- Canon reserves the right to change the specifications of the hardware and software described herein at anytime without prior notice.
- No part of this guide may be reproduced, transmitted, transcribed, stored in a retrieval system, or translated into any language in any form, by any means, without the prior written permission of Canon.
- Canon makes no warranties for damages resulting from corrupted or lost data due to a mistaken operation or malfunction of the camera, the software, SD memory cards (SD cards), personal computers, peripheral devices, or use of non-Canon SD cards.

## **Trademark Acknowledgments**

- Canon, PowerShot, PIXMA and SELPHY are trademarks of Canon Inc.
- Macintosh, Mac OS and QuickTime are trademarks of Apple Computer Inc., registered in the United States and/or other countries.
- Microsoft® and Windows® are either registered trademarks or trademarks of Microsoft Corporation in the United States and/or other countries.
- SD is a trademark.
- Other names and products not mentioned above may be registered trademarks or trademarks of their respective companies.



## **FCC Notice**

(Digital Camera, Model PC1108)

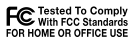

This device complies with Part 15 of the FCC Rules. Operation is subject to the following two conditions;

- (1) this device may not cause harmful interference, and
- (2) this device must accept any interference received, including interference that may cause undesired operation.

Note: This equipment has been tested and found to comply with the limits for Class B digital devices, pursuant to Part 15 of the FCC rules. These limits are designed to provide reasonable protection against harmful interference in a residential installation. This equipment generates, uses and can radiate radio frequency energy and, if not installed and used in accordance with the instructions, may cause harmful interference to radio communications. However, there is no guarantee that interference will not occur in a particular installation. If this equipment does cause harmful interference to radio or television reception, which can be determined by turning the equipment off and on, the user is encouraged to try to correct the interference by one or more of the following measures:

- Reorient or relocate the receiving antenna.
- Increase the separation between the equipment and receiver.
- Connect the equipment into an outlet on a circuit different from that to which the receiver is connected.
- Consult the dealer or an experienced radio/TV technician for help.

The cable with the ferrite core provided with the digital camera must be used with this equipment in order to comply with Class B limits in Subpart B of Part 15 of the FCC rules.

Do not make any changes or modifications to the equipment unless otherwise specified in the manual. If such changes or modifications should be made, you could be required to stop operation of the equipment.

Canon U.S.A. Inc.

One Canon Plaza, Lake Success, NY 11042, U.S.A.

Tel No. (516) 328-5600

## **Canadian Radio Interference Regulations**

This Class B digital apparatus complies with Canadian ICES-003.

## **Réglementation canadienne sur les interférences radio**

Cet appareil numérique de la classe B est conforme à la norme NMB-003 du Canada.

## Functions Available in Each Shooting Mode

The chart below is a reference for the settings available for various shooting conditions. The settings selected in each shooting mode are saved after you finish shooting.

Function		📷 Shooting							🎬 Movie	Page	
Resolution	Large	<b>L</b>	○*	○*	○*	○*	○*	○*	△*	-	p. 58
	Medium 1	<b>M1</b>	○	○	○	○	○	○	△	-	
	Medium 2	<b>M2</b>	○	○	○	○	○	○	△	-	
	Small	<b>S</b>	○	○	○	○	○	○	△	-	
	Postcard		○	○	○	○	○	○	-	-	
	Movie	<b>640</b>	-	-	-	-	-	-	-	○	
	Movie	<b>320</b>	-	-	-	-	-	-	-	○*	
Compression	Superfine	<b>S</b>	○	○	○	○	○	○	△	-	p. 58
	Fine		○*	○*	○*	○*	○*	○*	△*	-	
	Normal		○	○	○	○	○	○	△	-	
Flash	Auto		○	○	-	○	○	○*	-	-	p. 60
	Auto with Red-Eye Reduction		○*	○*	-	○*	○	○	-	-	
	On with Red-Eye Reduction		-	-	-	○	○	○	-	-	
	On		-	○	-	○	○	○	△	-	
	Off		○	○	○	○	○*	○	△*	-	
	Slow Synchro		-	○	-	-(1)	-	-	△	-	
Quick Shot		○	○	-	-	-	-	-	-	p. 44	
Shooting Method	Single		○*	○*	○*	○*	○*	○*	△*	○*	-
	Continuous Shooting		-	○	○	○	○	○	-	-	p. 65
	10-sec. Self-timer		○	○	○	○	○	○	△	○	p. 68
	2-sec. Self-timer		○	○	○	○	○	○	△	○	
Date Stamp		○	○	○	○	○	○	-	-	p. 67	
Autofocus Modes		-	○	○	○	○	○	-	-	p. 75	
AF-assist Beam		○	○	○	○	○	○	△	○	p. 44	

Function		Shooting							Movie	Page
<b>Digital Zoom</b>		○	○	○	○	○	○	–	–	p. 42
<b>Light Metering Method</b>	Evaluative	○	○*	○*	○	○	○	○	○	p. 78
	Center-Weighted Average	–	○	○	–	–	–	–	–	
	Spot	–	○	○	–	–	–	–	–	
<b>Exposure Compensation</b>		–	○	○	○	○	○	△	○	p. 79
<b>Long Shutter</b>		–	○	–	–	–	–	–	–	p. 80
<b>White Balance</b>		–	○	○	–(2)	–(2)	–(2)	△	○	p. 82
<b>Photo Effect</b>		–	○	○	–(2)	–(2)	–(2)	△	○	p. 86
<b>ISO Speed</b>		–(2)	○	○	–(2)	–(2)	–(2)	–(2)	–(2)	p. 87
<b>Auto Rotate</b>		○	○	○	○	○	○	△	–	p. 88

\* Default setting

○ Setting available

△ Setting can only be selected for the first image.

■ (Shaded Area): Setting is memorized even when the camera power is shut off.

(1) In (Night snapshot) mode, the flash will automatically fire in Slow Synchro.

(2) The ISO speed is automatically set.

With the exception of the [Date/Time], [Language] and [Video System] menu settings, all the other menu settings and changes made with the camera buttons can be reset to the default values in a single operation (p. 54).